

تم تحميل هذا الملف من موقع المناهج الإماراتية



كتابي الرابع عن الأبجدية العربية

موقع المناهج ← المناهج الإماراتية ← الصف الأول ← لغة عربية ← الفصل الثاني ← ملفات متنوعة ← الملف

تاريخ إضافة الملف على موقع المناهج: 2025-01-10 14:18:10

ملفات اكتب للمعلم اكتب للطالب الاختبارات الكترونية | اختبارات | حلول | عروض بوربوينت | أوراق عمل
منهج انجليزي | ملخصات وتقارير | مذكرات وبنوك | الامتحان النهائي للمدرس

المزيد من مادة
لغة عربية:

إعداد: twinkl

التواصل الاجتماعي بحسب الصف الأول



صفحة المناهج
الإماراتية على
فيسبوك

الرياضيات

اللغة الانجليزية

اللغة العربية

التربية الاسلامية

المواد على تلغرام

المزيد من الملفات بحسب الصف الأول والمادة لغة عربية في الفصل الثاني

كتابي الثالث عن الأبجدية العربية

1

كتابي الثاني عن الأبجدية العربية

2

كتابي الأول عن الأبجدية العربية

3

كتاب الطالب المجلد الثاني للعام 2024-2025

4

عرض بوربوينت قصة فوفي يقهر خوفه الوعي الصوتي والحركات القصيرة

5

كتابي الرابع عن الأبجدية العربية

ع

ع

ع

ع



مقدمة

هذا الكتاب هو الجزء الرابع من سلسلة كتبي عن الأبجدية العربية التي يقدمها لكم موقع توينكل التعليمي، حيث إنه بعد أن تم تدريب الطفل على حركات القلم الأساسية التي سيستخدمها عند كتابة حروف اللغة العربية طبقاً للجزء الأول، وبعد أن تدرّب على كتابة الحروف الأبجدية ذاتها والتحكم في القلم لكتابتها بشكل واضح ومحدد وبخط منظم طبقاً للجزء الثاني، وبعد أن تدرّب جيداً على ترتيب الحروف الأبجدية ونطقها بشكل صحيح طبقاً للجزء الثالث، أصبح الطفل الآن جاهزاً للتدرب على أشكال الحروف العربية المختلفة حسب موقعها في الكلمة.

وقد تم تصميم هذا الكتاب بحيث تتناول كل صفحتين تدريباً على كتابة أحد حروف اللغة العربية بأشكاله المختلفة حسب موقعه في الكلمة، بالإضافة إلى إدراج رسومات لأشياء مختلفة تحتوي على الحروف سواء في أولها أو أوسطها أو آخرها حتى يلوّنها الطفل ويتدرب على نطق الحرف في الكلمة.

تلوين وكتابة الحرف "أ"

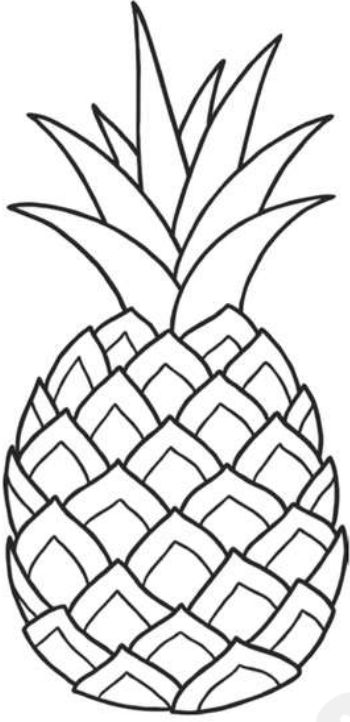

تلوين وكتابة الحرف "أ"

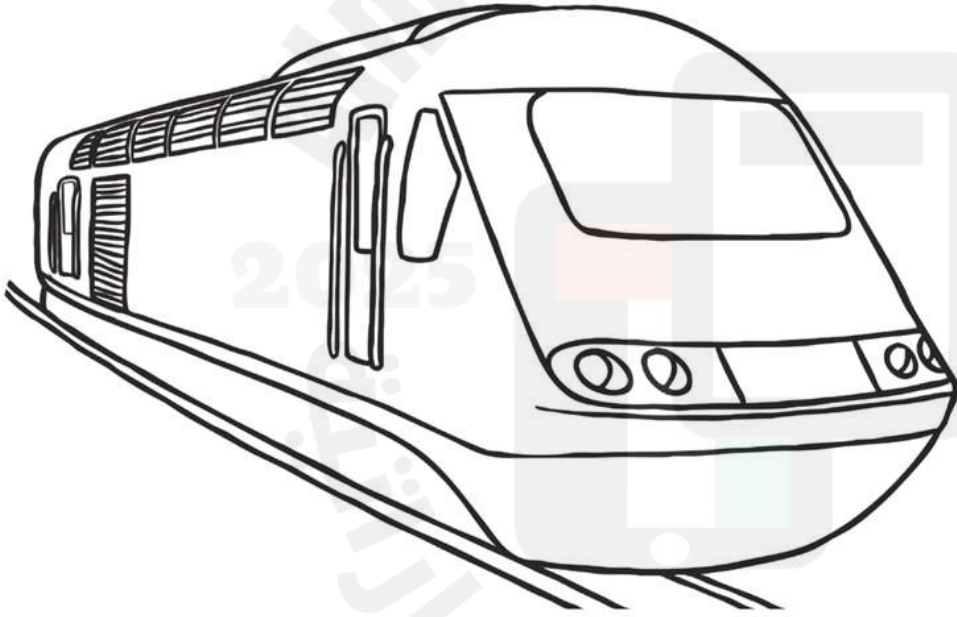
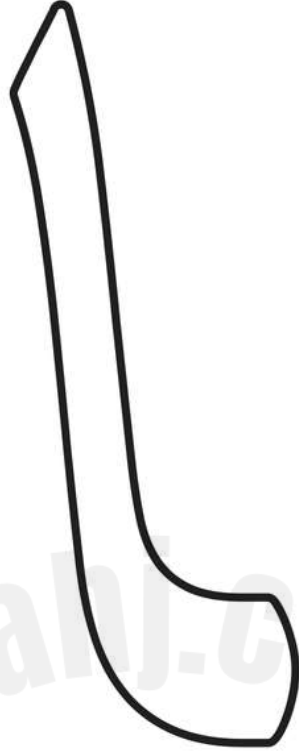

تلوين وكتابة الحرف "ب"

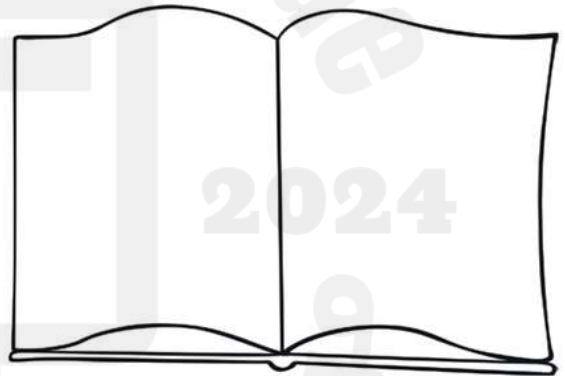
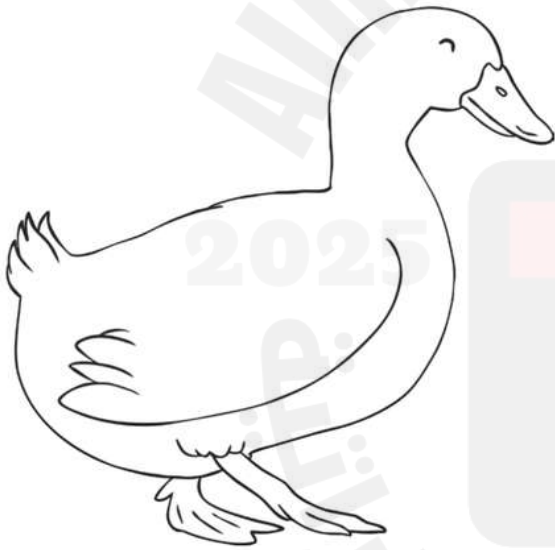

تلوين وكتابة الحرف "ب"

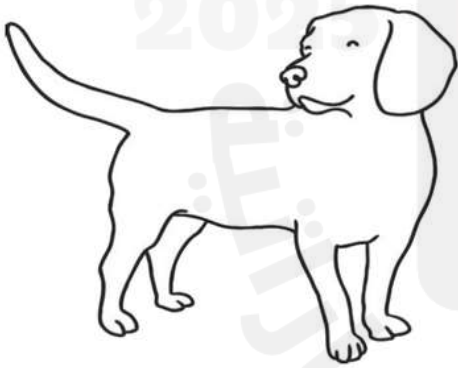
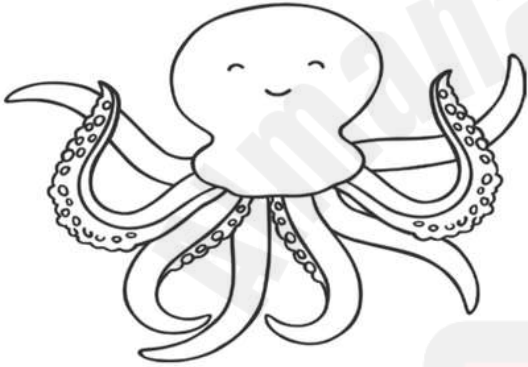
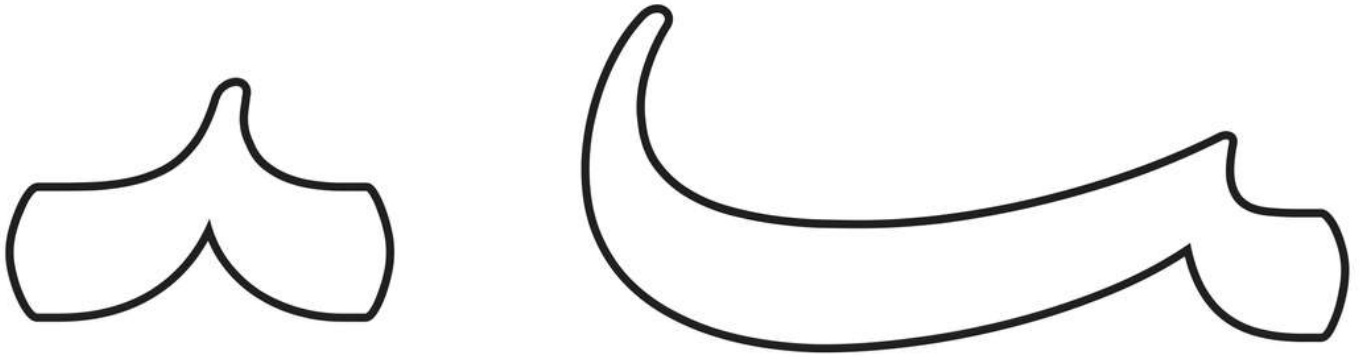

تلوين وكتابة الحرف "ت"

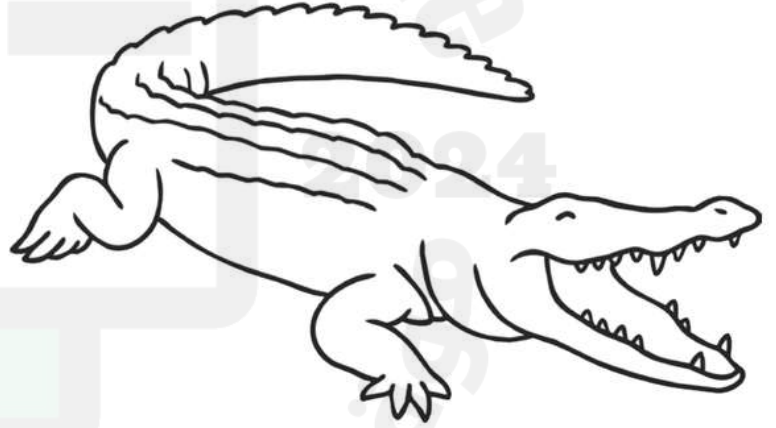
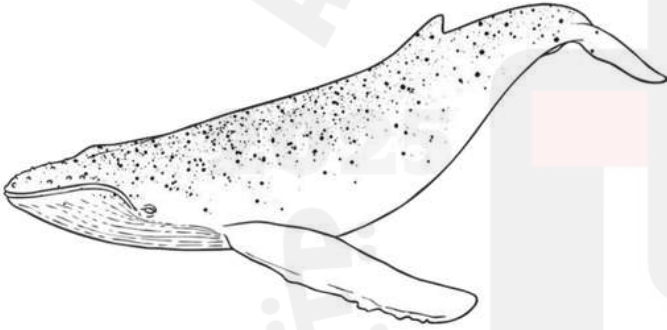
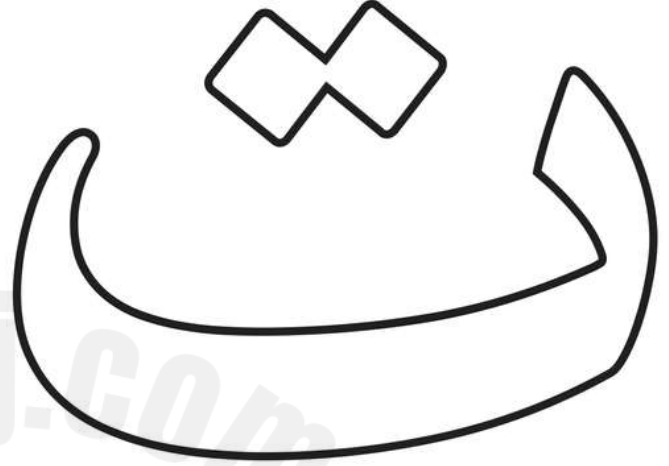
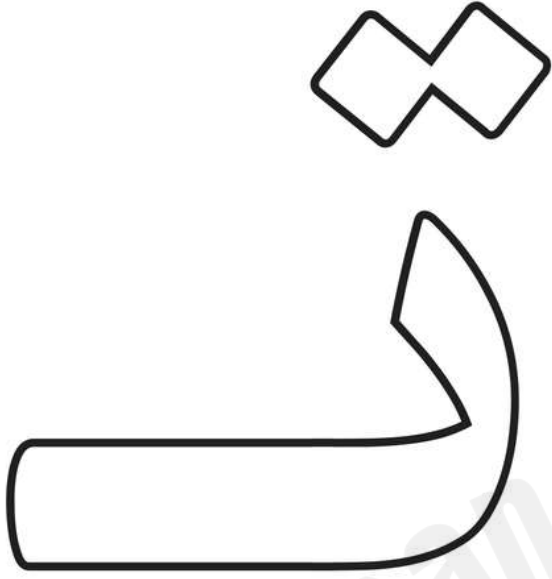

ت

ت

ت

ت

ت

ت

ت

ت

ت

ت

ت

ت



تلوين وكتابة الحرف "ت"

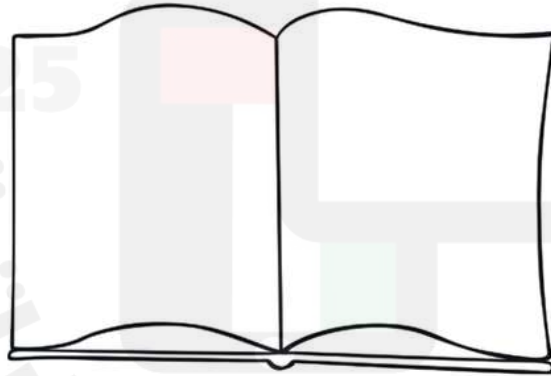
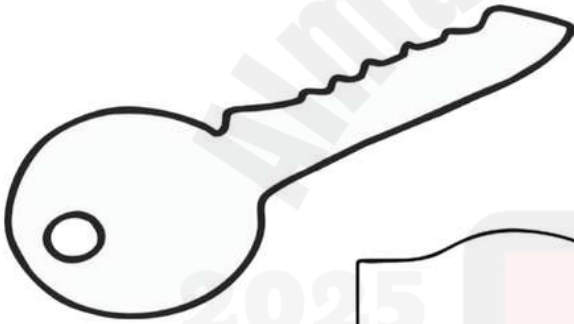
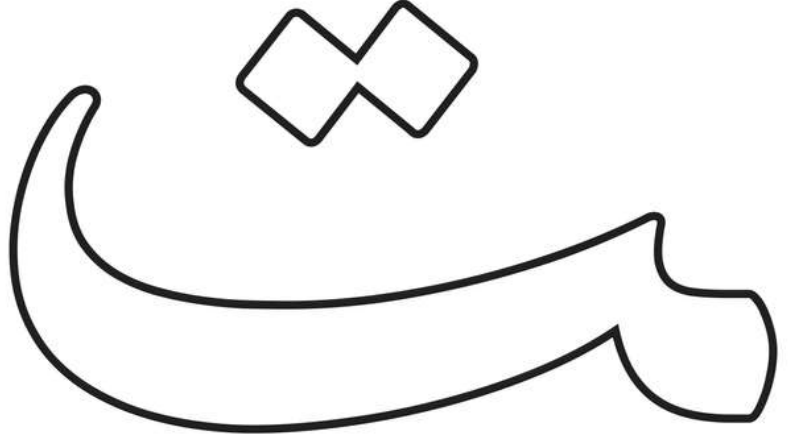
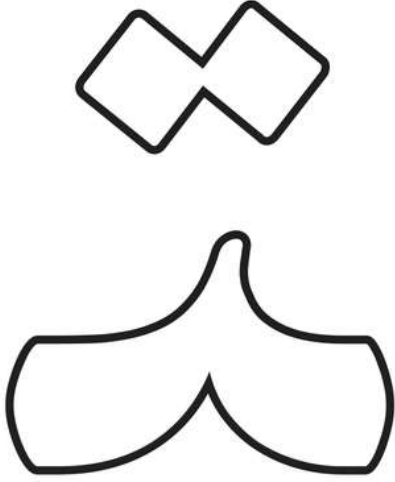

تلوين وكتابة الحرف "ث"

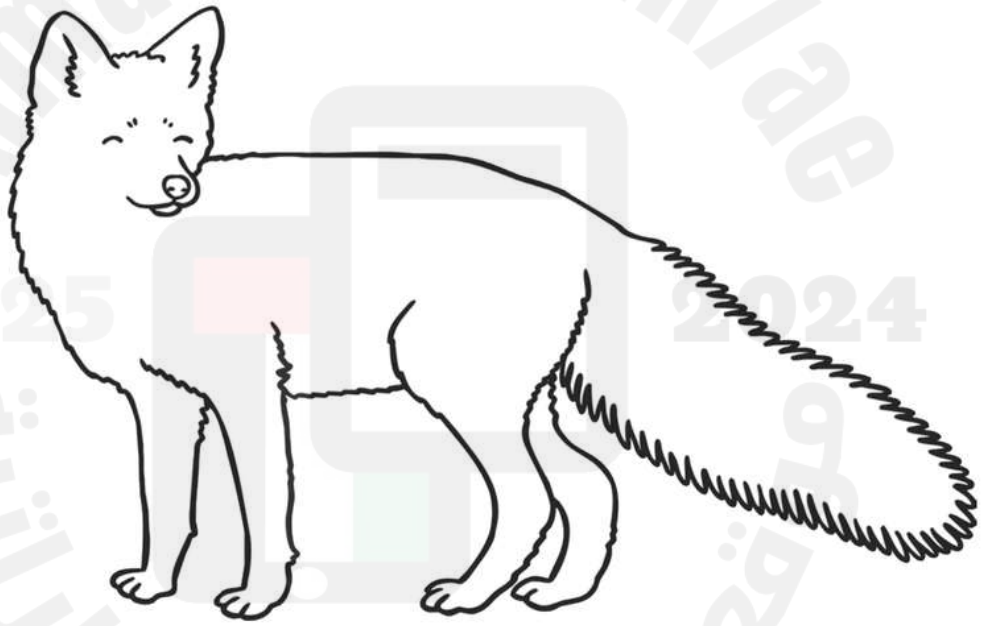
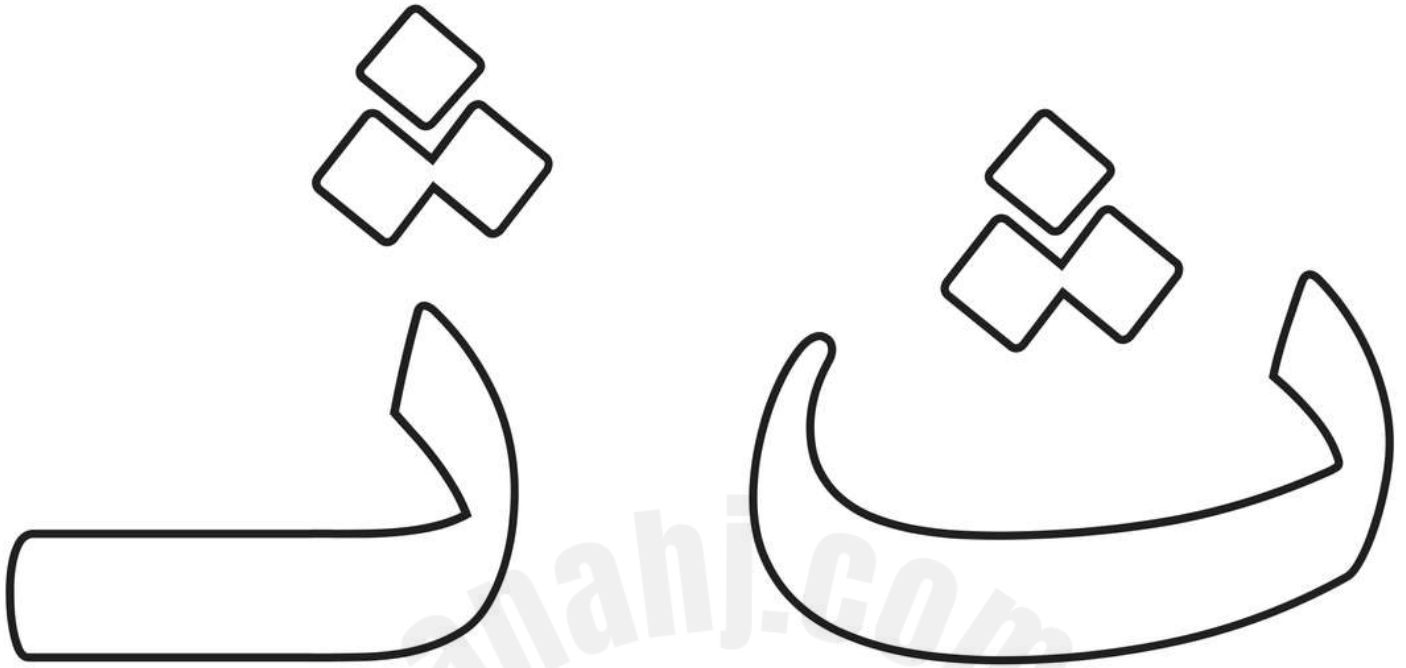

تلوين وكتابة الحرف "ث"

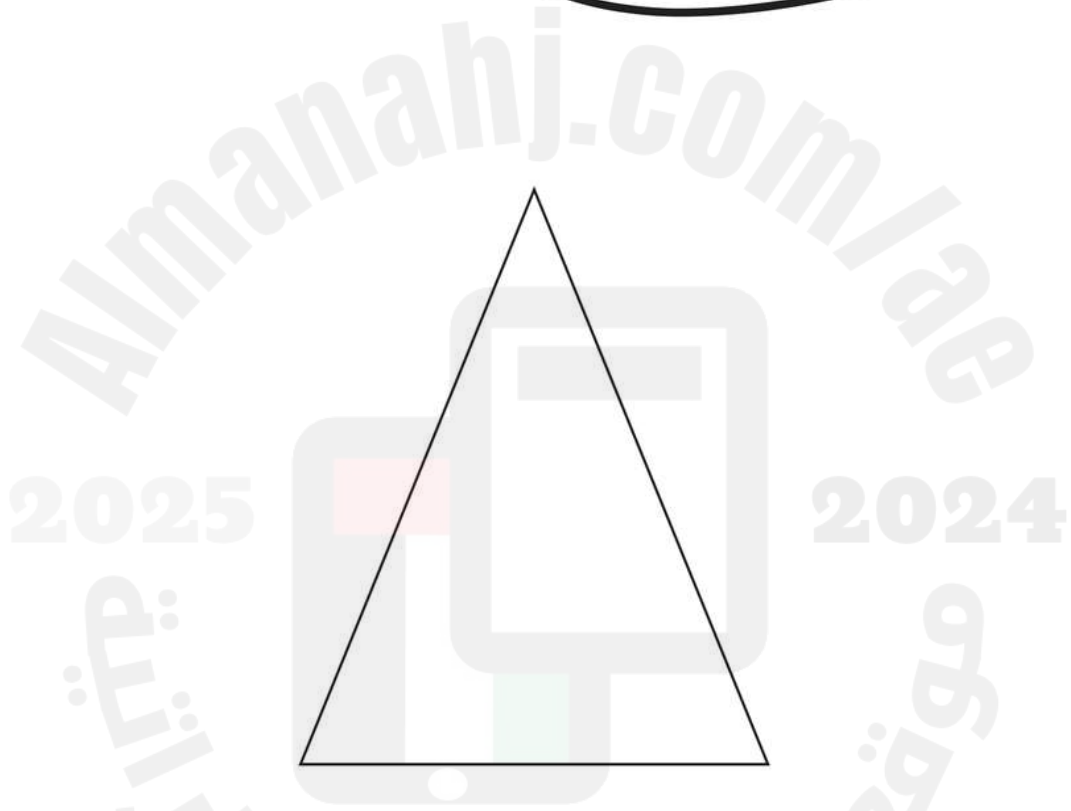
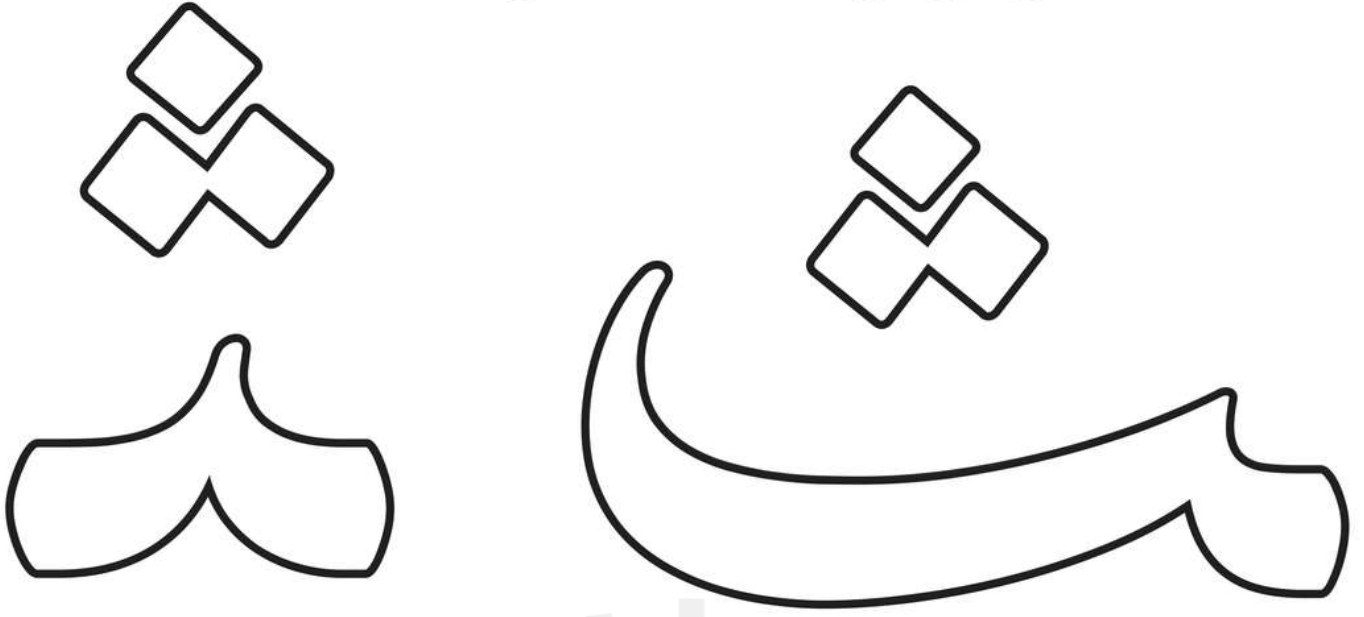

تلوين وكتابة الحرف "ج"

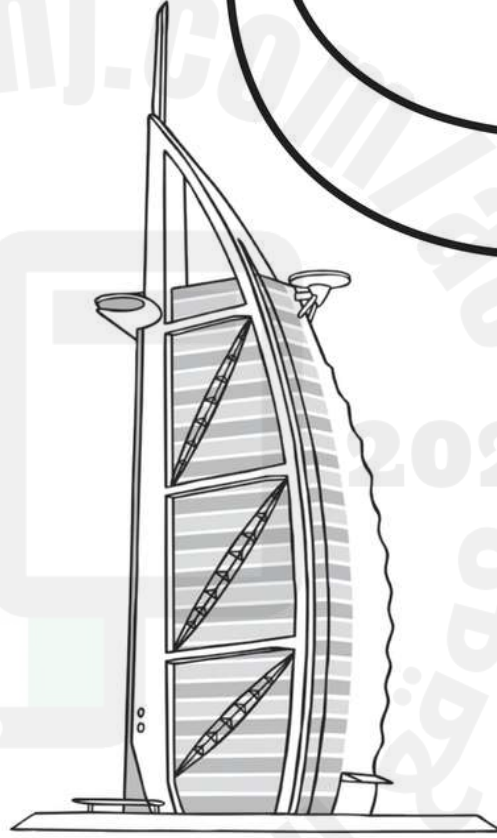
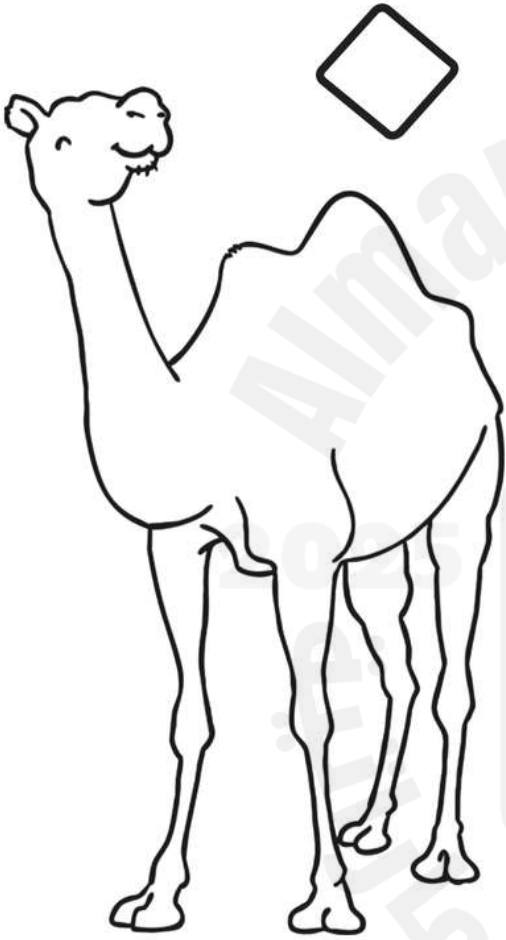
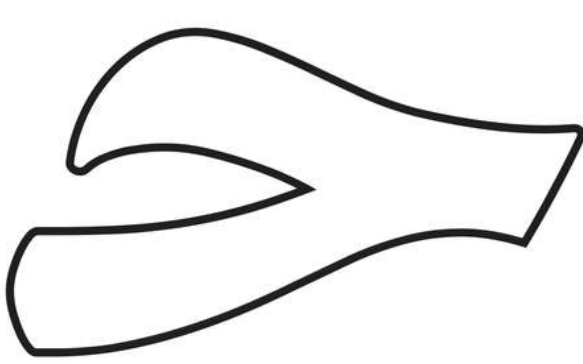

تلوين وكتابة الحرف "ج"

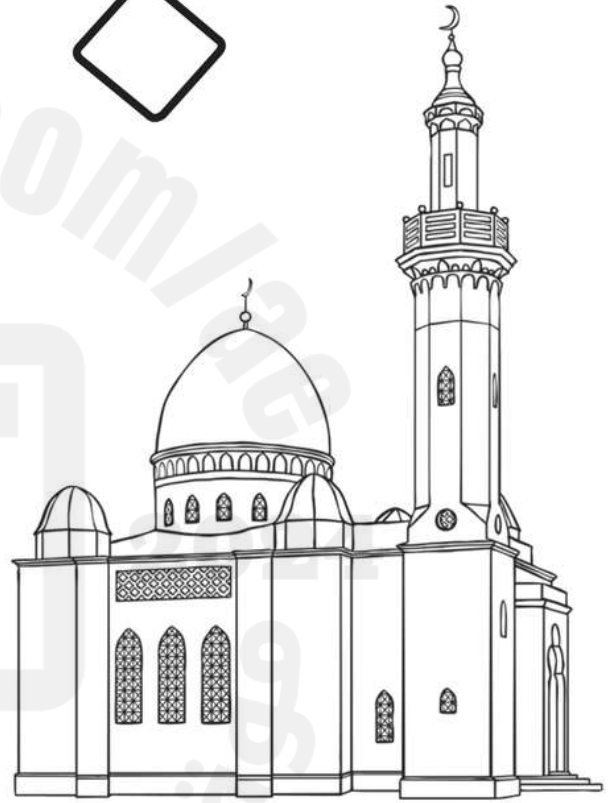
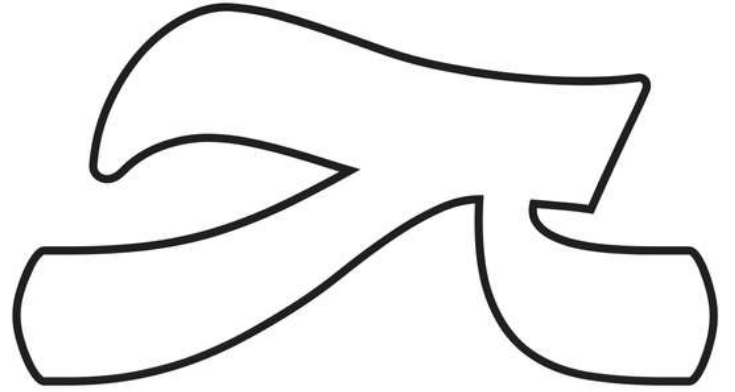

تلوين وكتابة الحرف "ح"

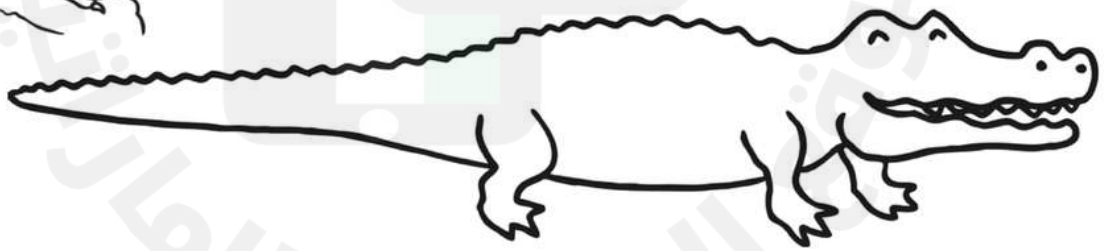
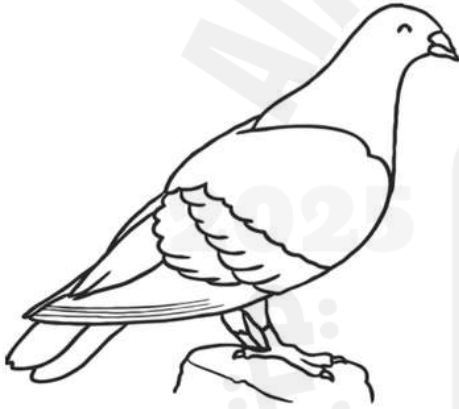

تلوين وكتابة الحرف "ح"

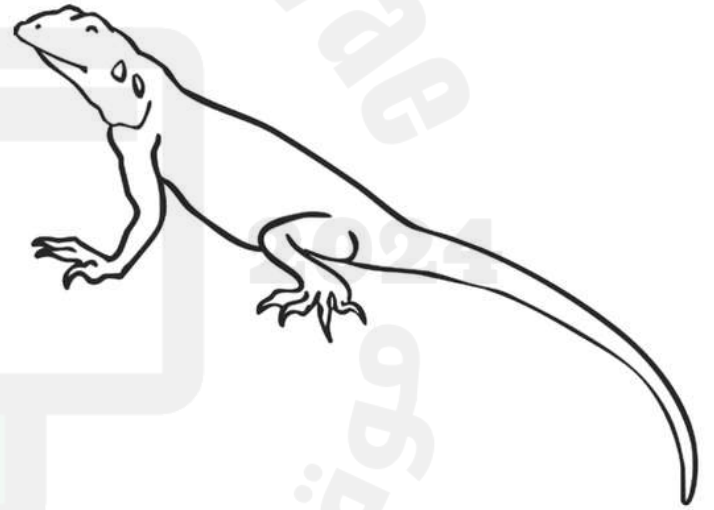
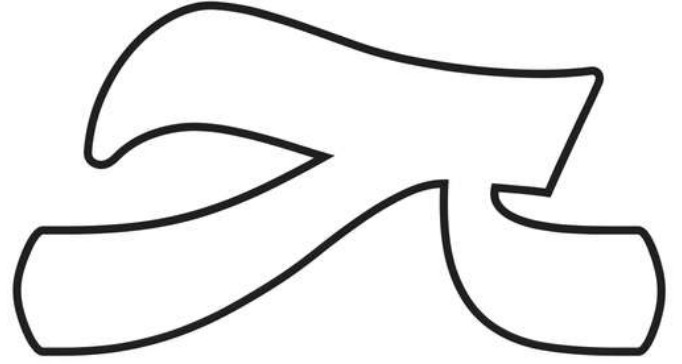

تلوين وكتابة الحرف "خ"



تلوين وكتابة الحرف "خ"

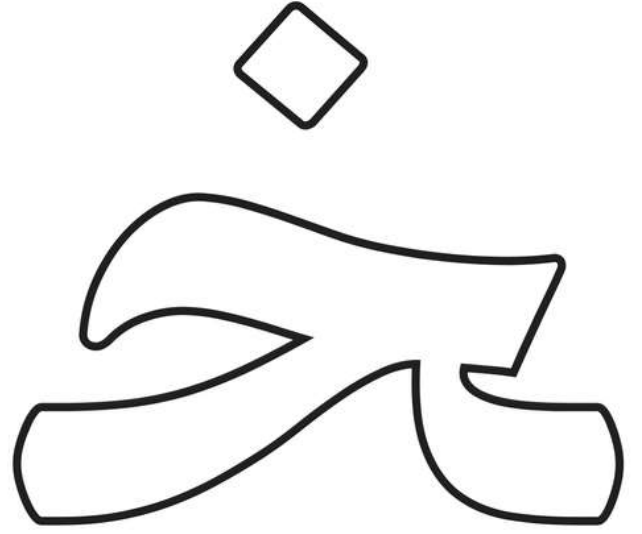
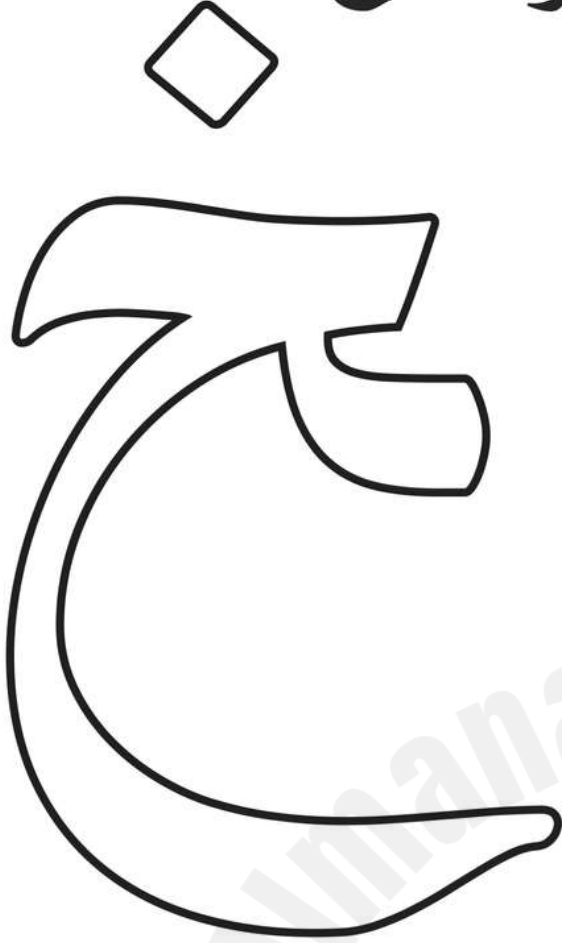

خ
خ

خ
خ

خ
خ

خ
خ

خ
خ



تلوين وكتابة الحرف "د"

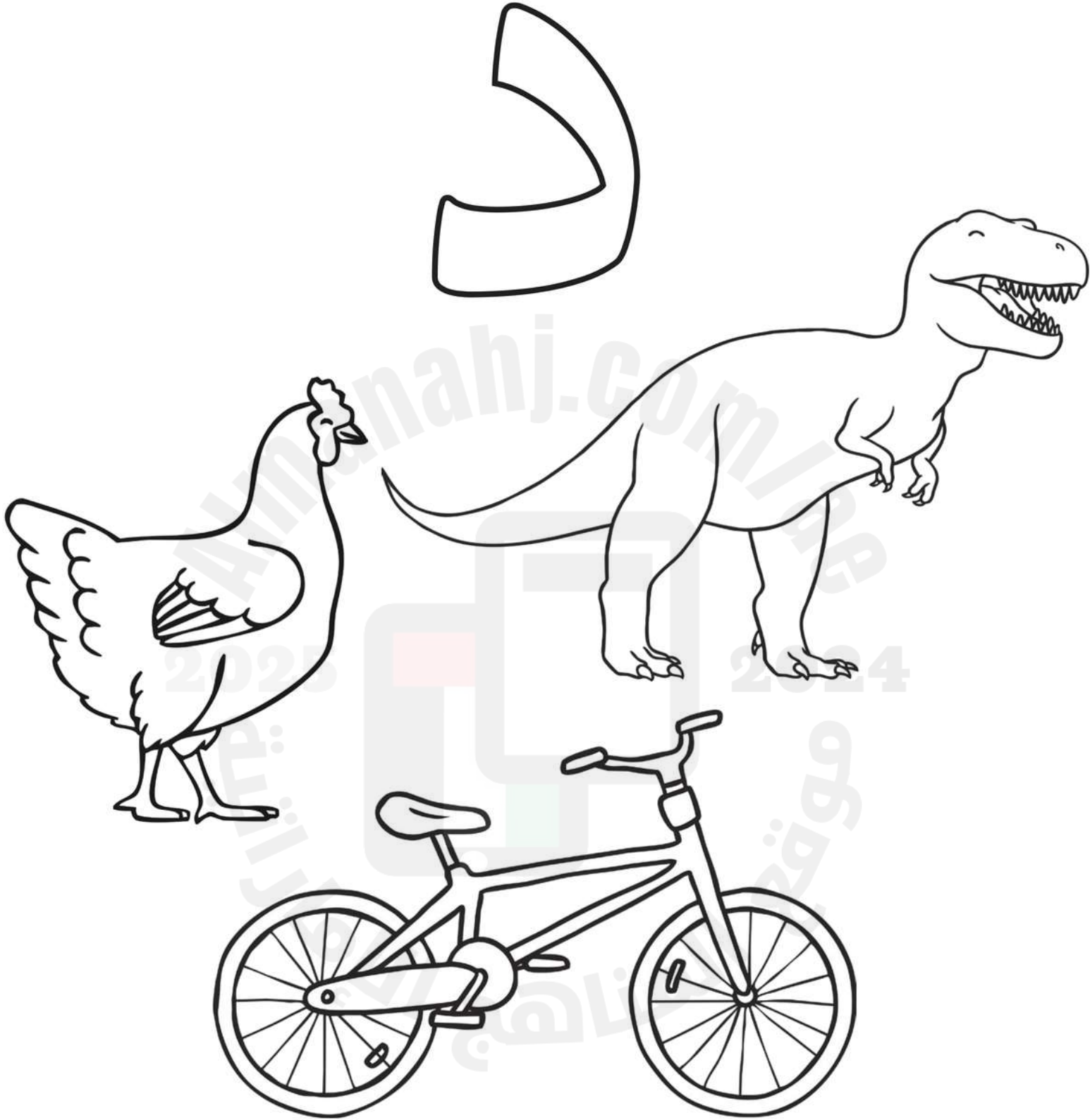

تلوين وكتابة الحرف "د"

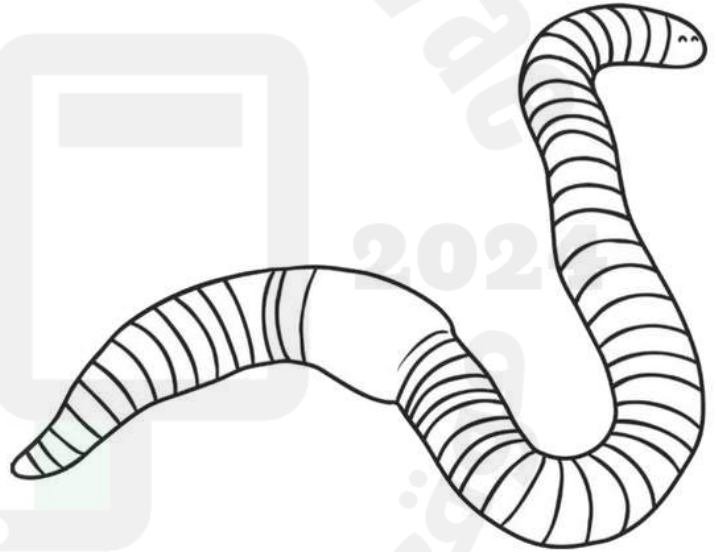
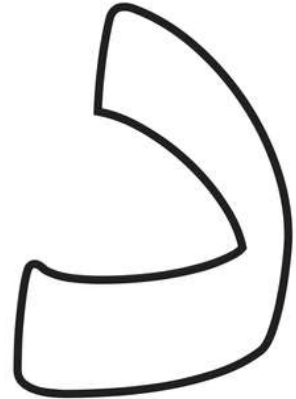
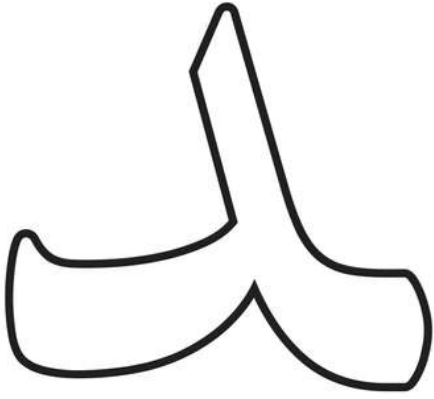

تلوين وكتابة الحرف "ذ"

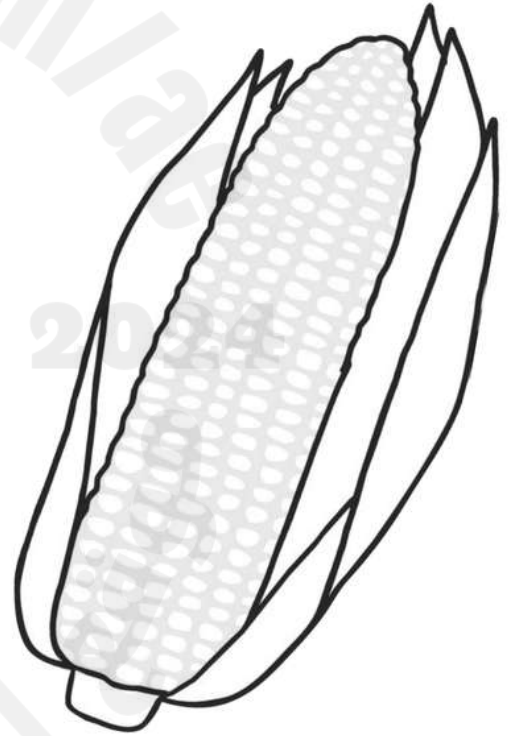
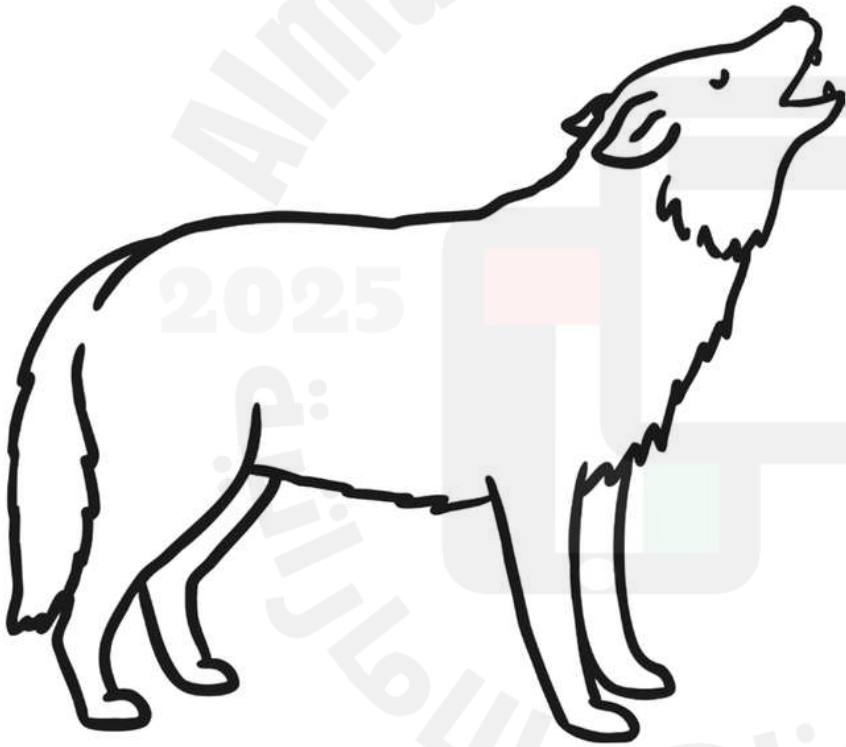

ذ ذ ذ ذ ذ ذ



تلوين وكتابة الحرف "ذ"

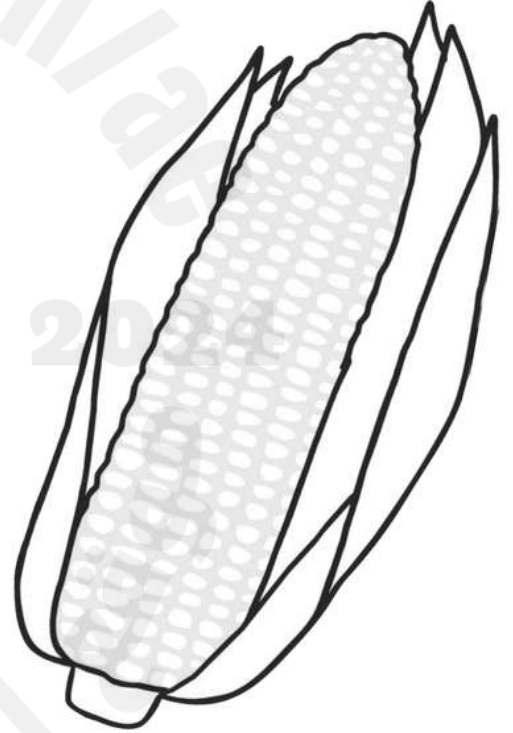
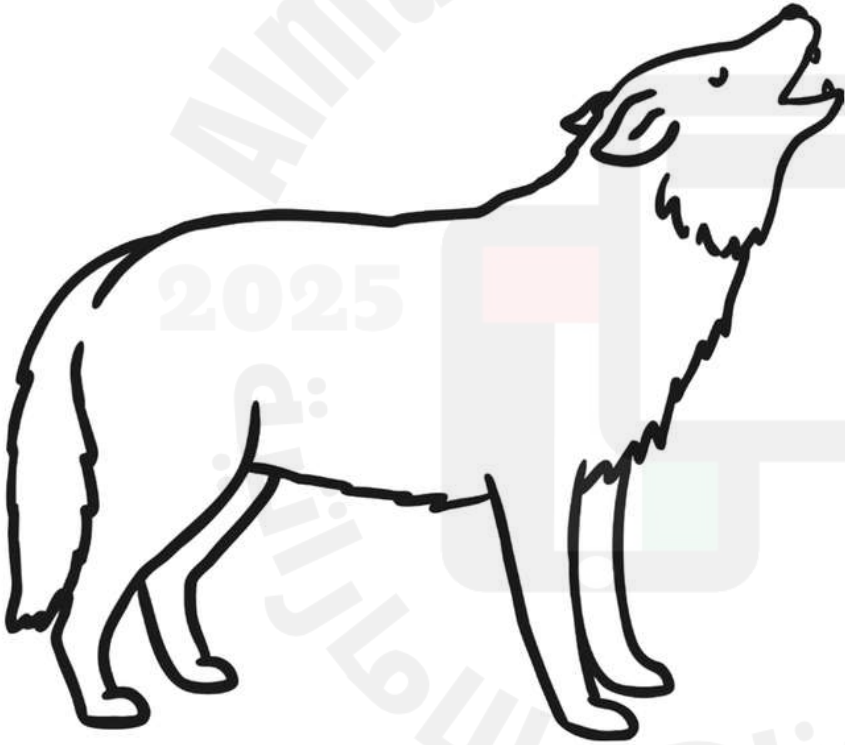

ذ ذ ذ ذ ذ ذ



تلوين وكتابة الحرف "ذ"

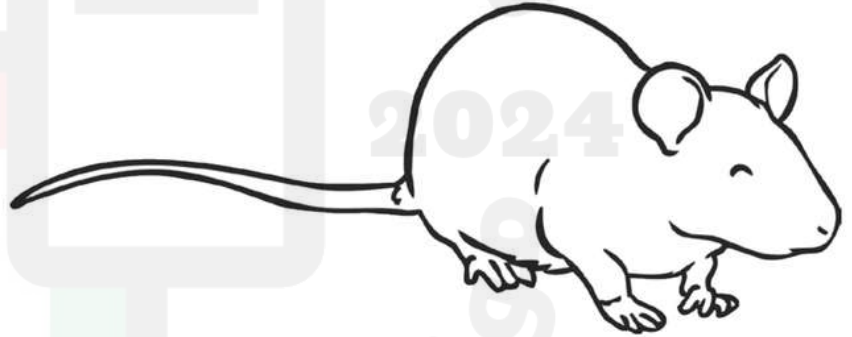
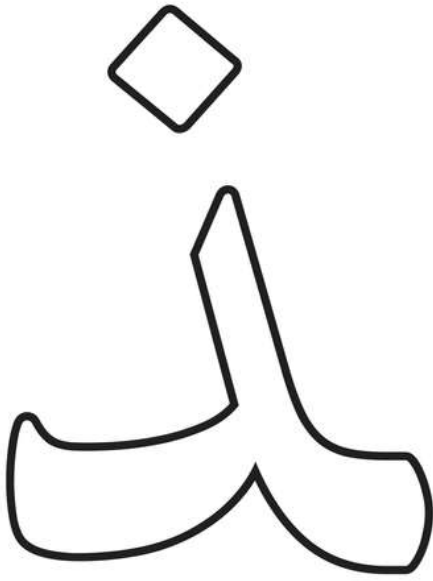

تلوين وكتابة الحرف "ر"

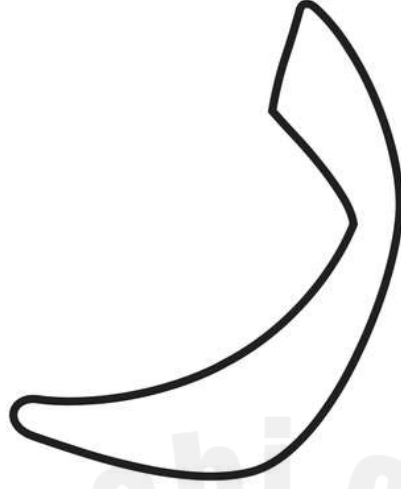

تلوين وكتابة الحرف "ر"

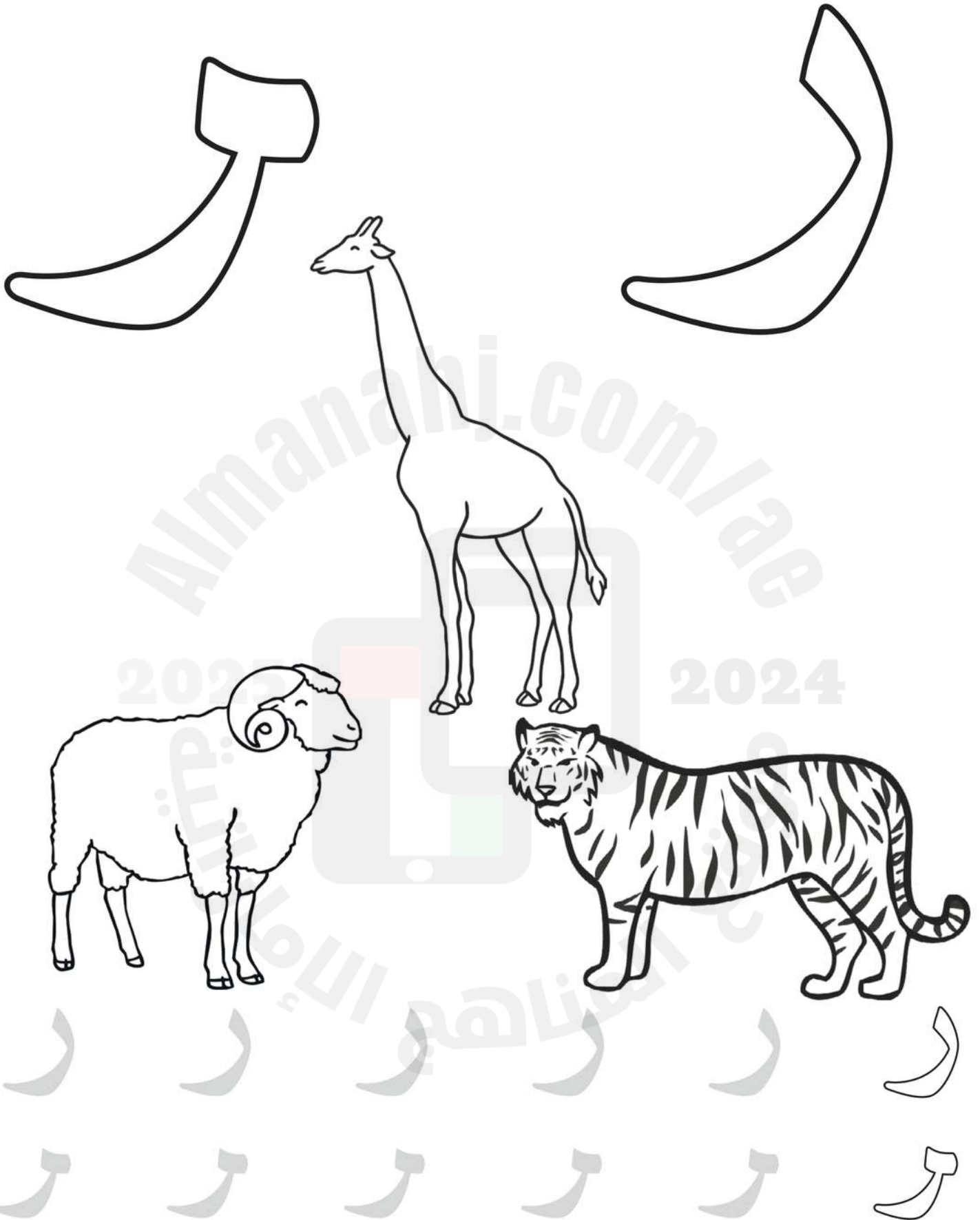

تلوين وكتابة الحرف "ز"

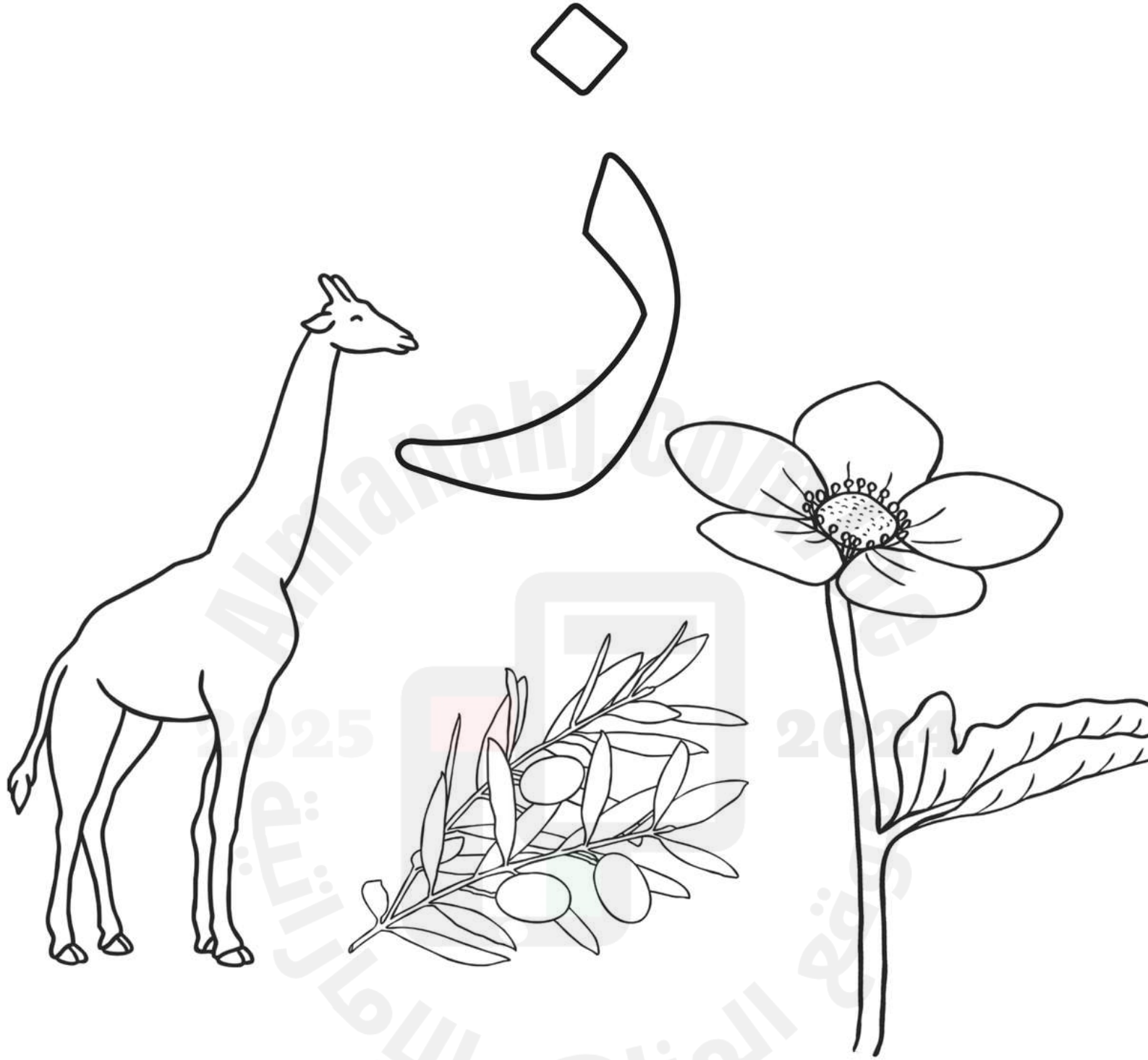

تلوين وكتابة الحرف "ز"

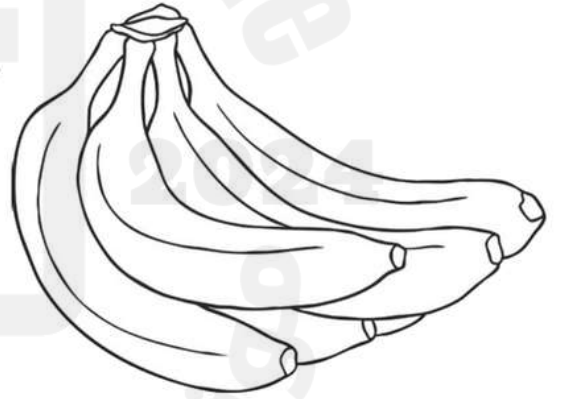
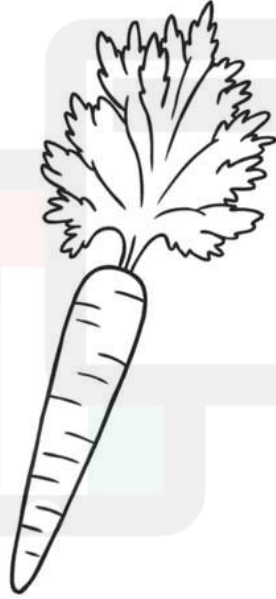
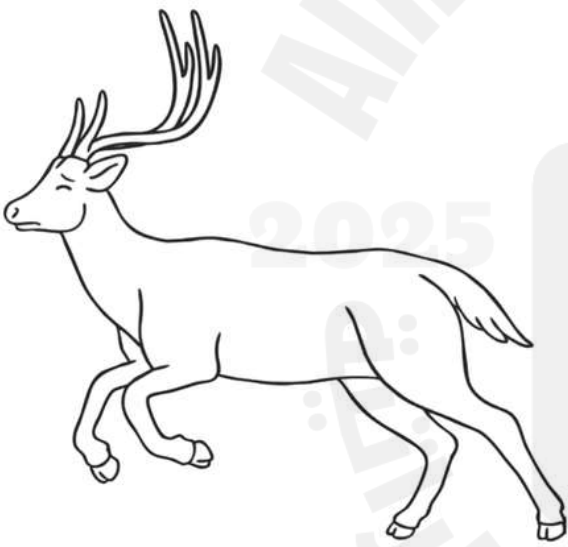
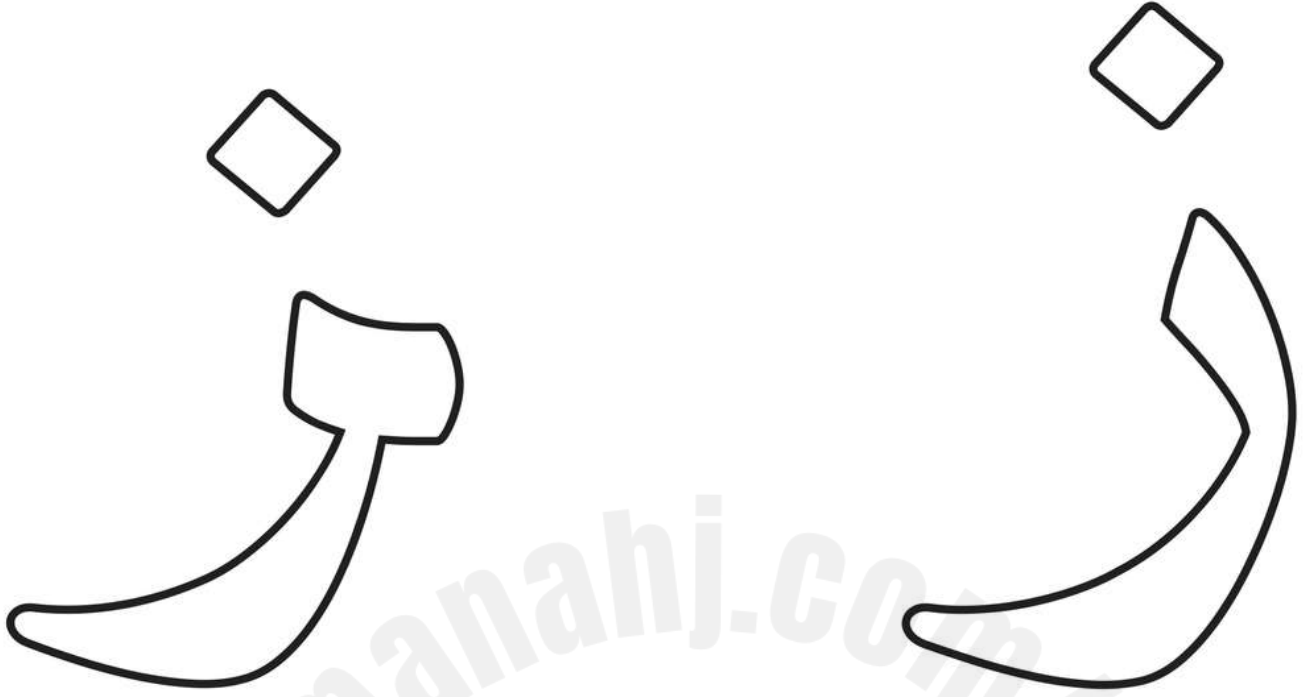

تلوين وكتابة الحرف "س"

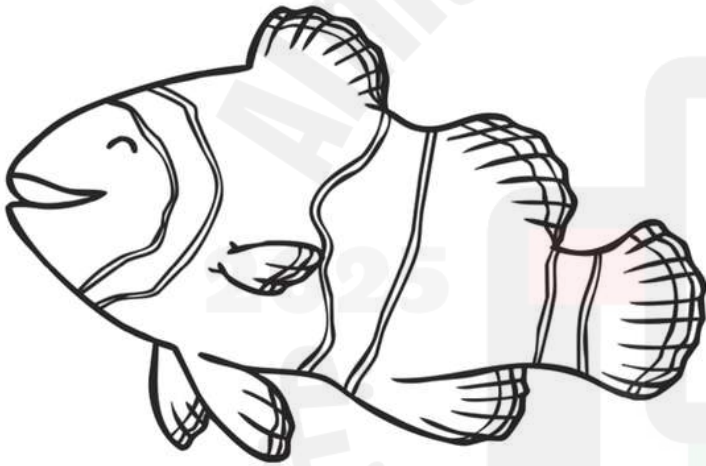

س

س

س

س

س

س

س

س

س

س

س

س



تلوين وكتابة الحرف "س"

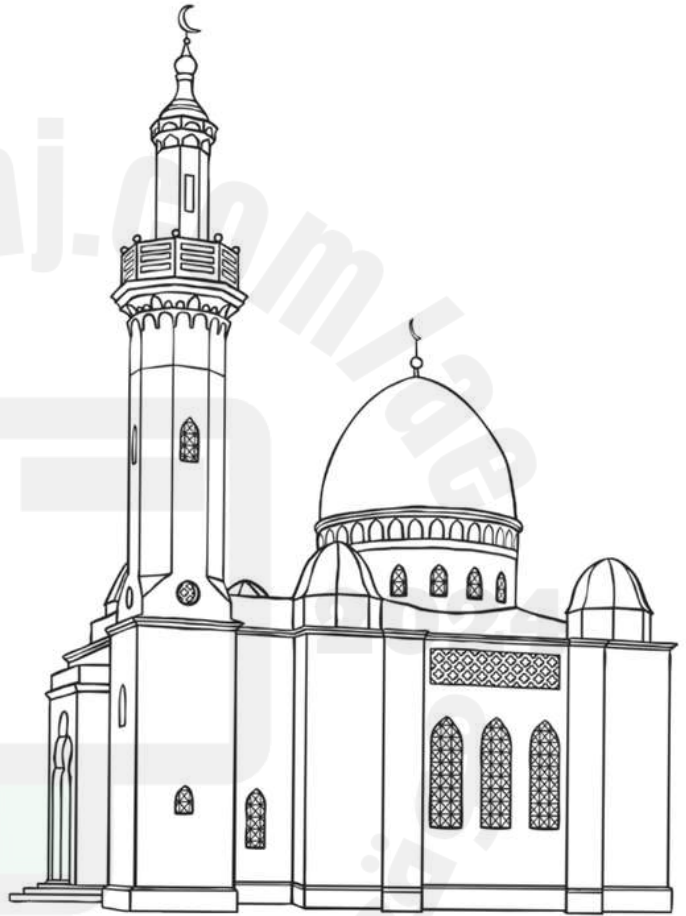
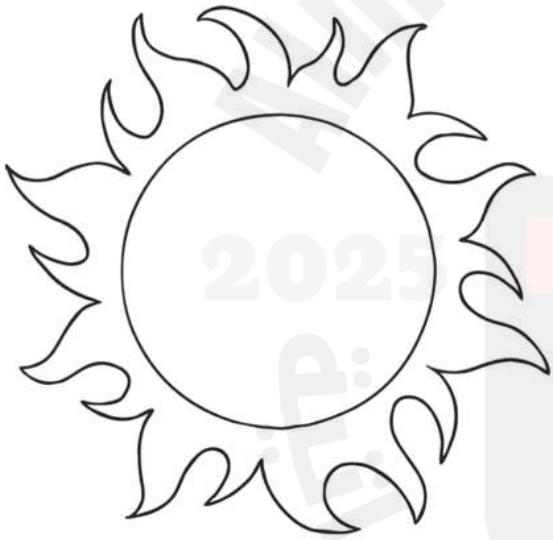
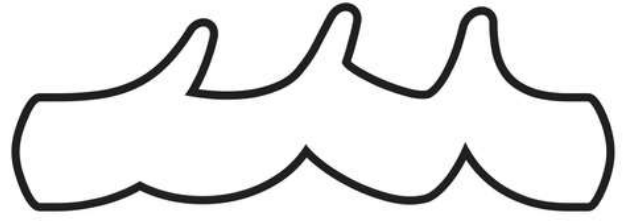
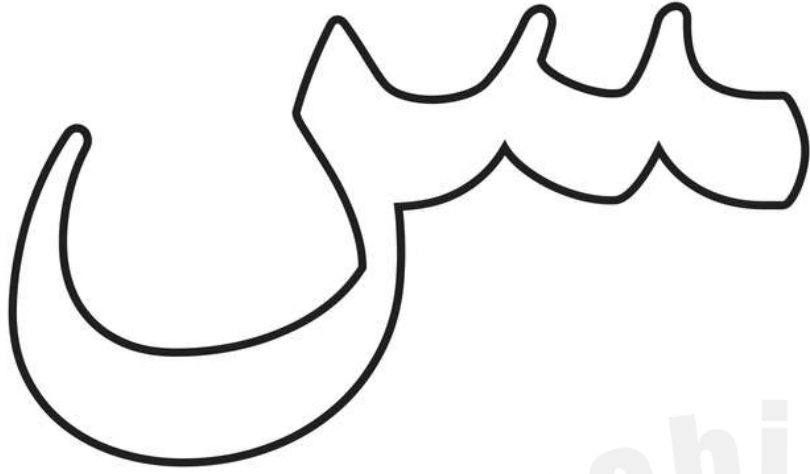

تلوين وكتابة الحرف "ش"

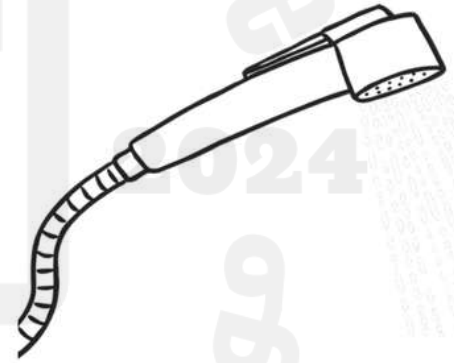
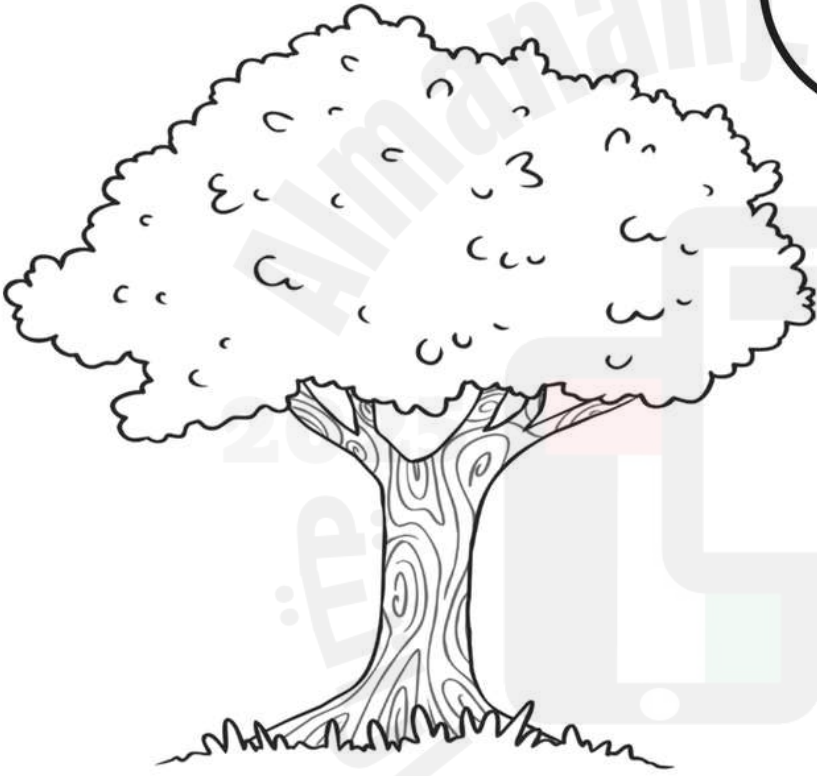
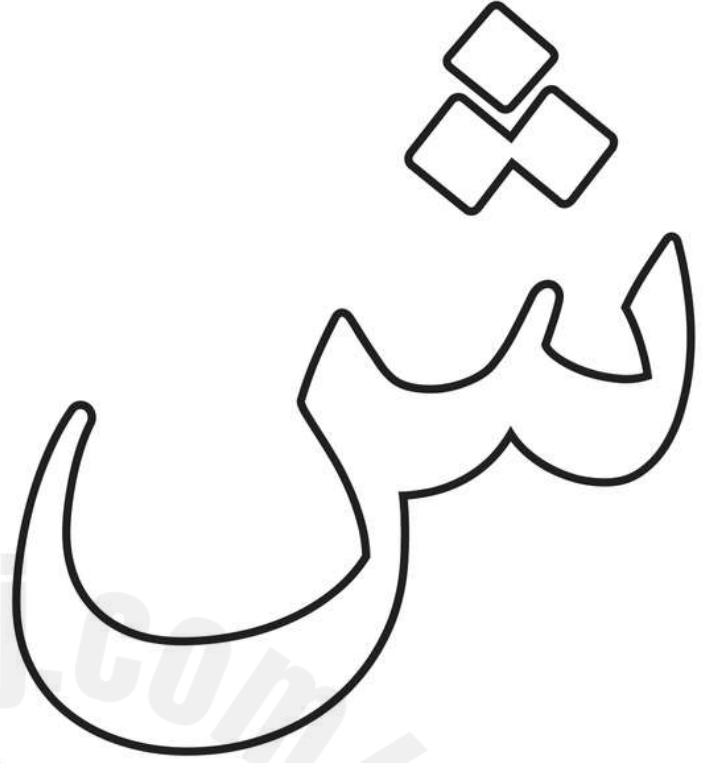
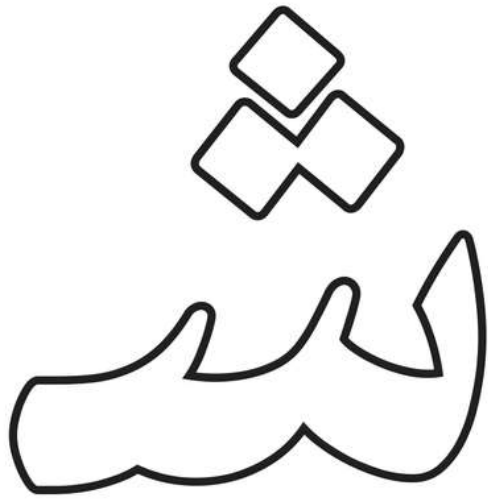

تلوين وكتابة الحرف "ش"

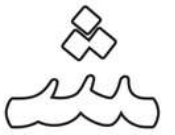
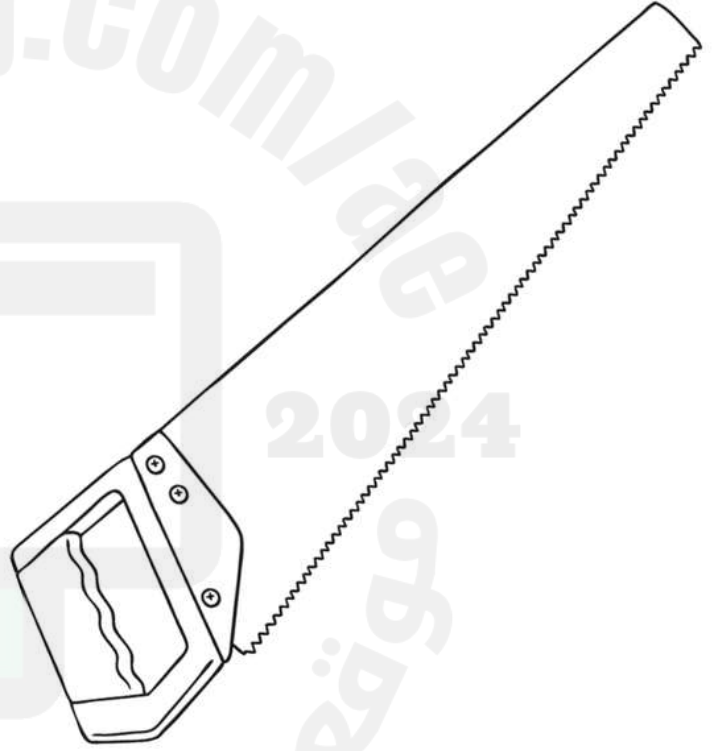
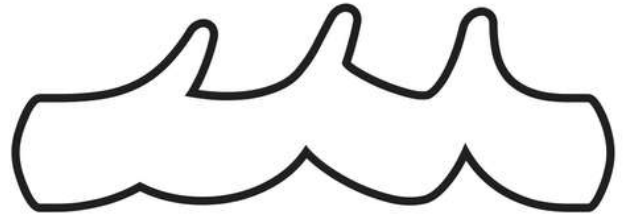
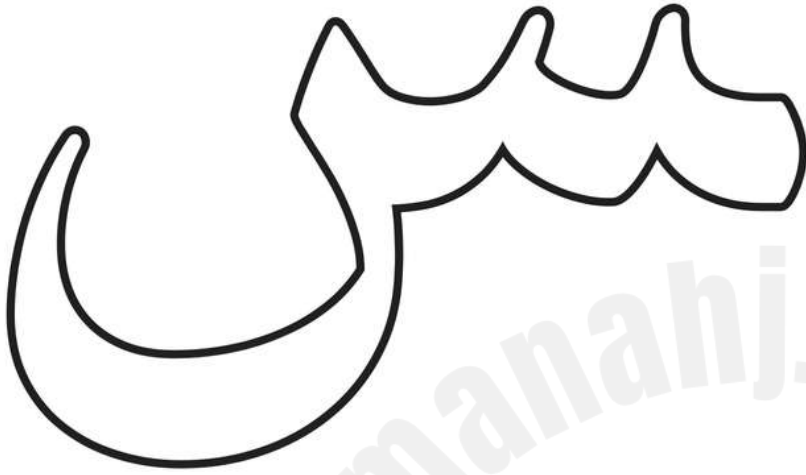
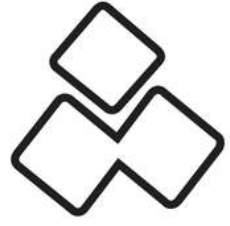
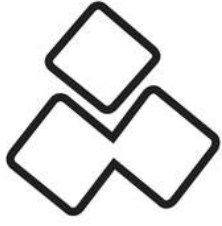

تلوين وكتابة الحرف "ص"

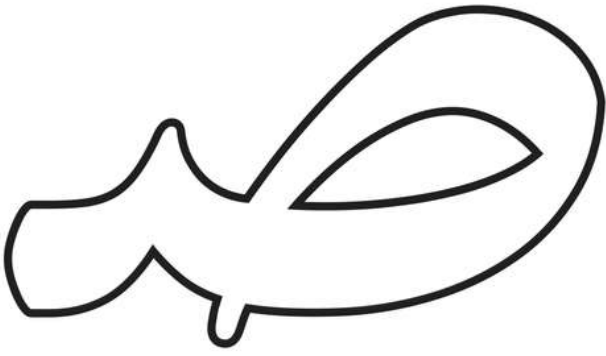

تلوين وكتابة الحرف "ص"

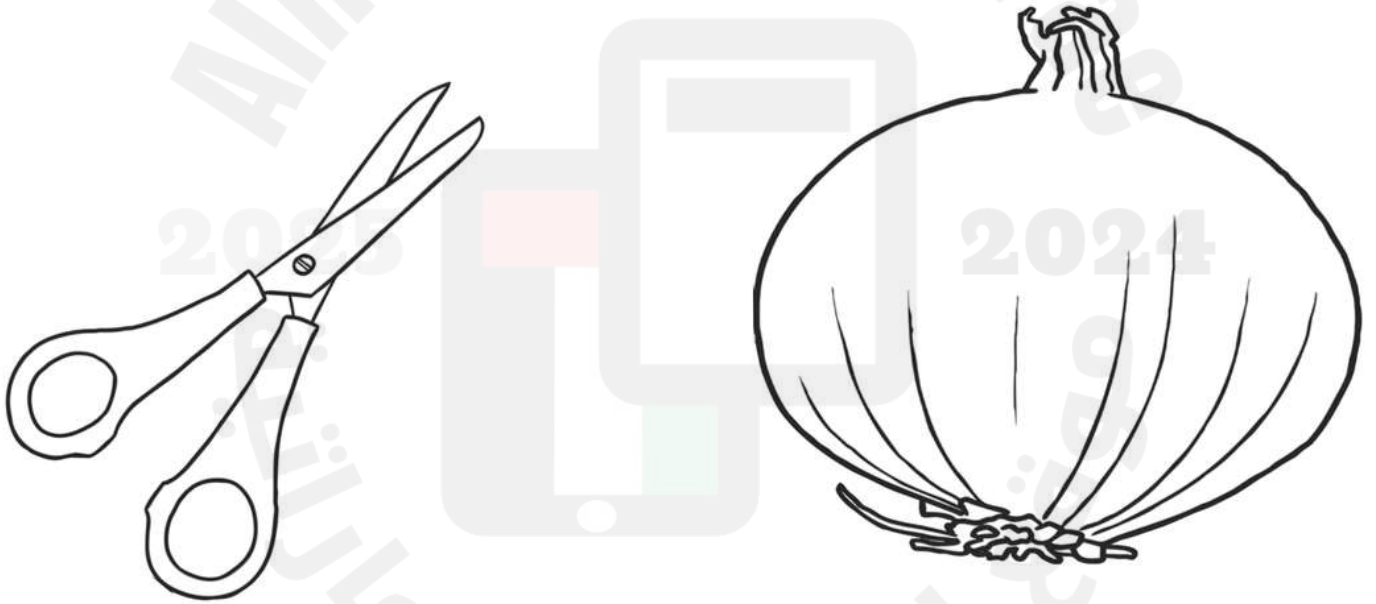

تلوين وكتابة الحرف "ض"

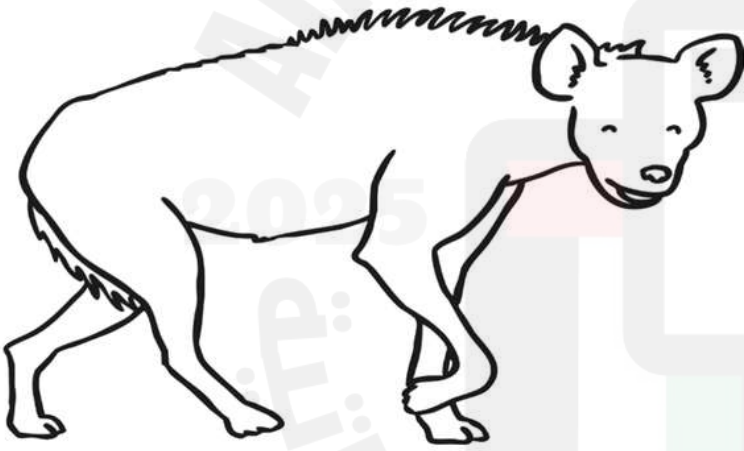
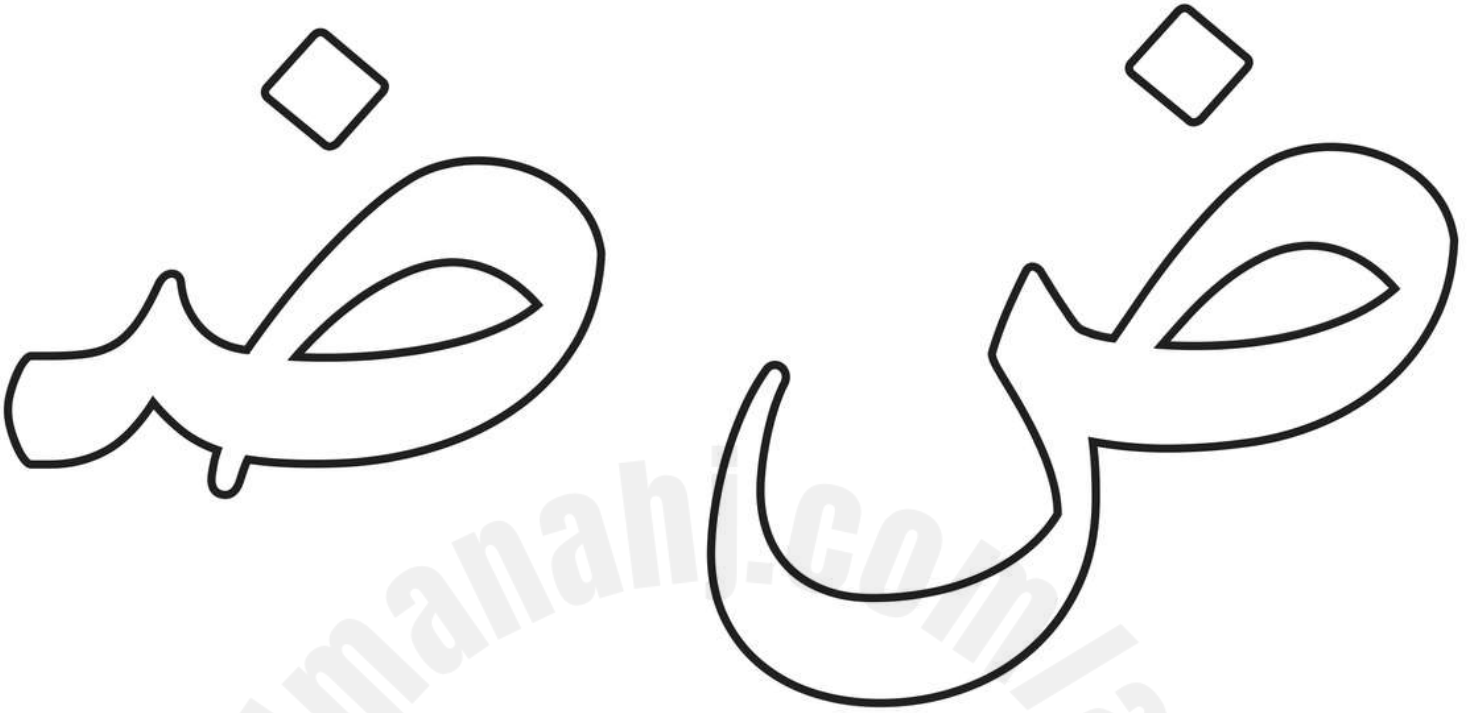

تلوين وكتابة الحرف "ط"

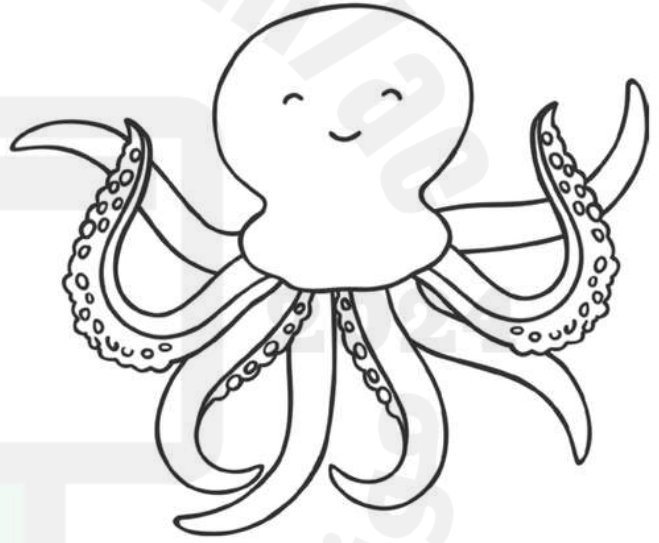
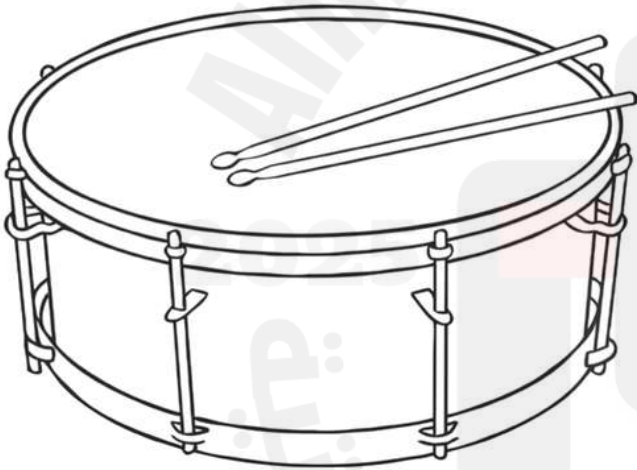
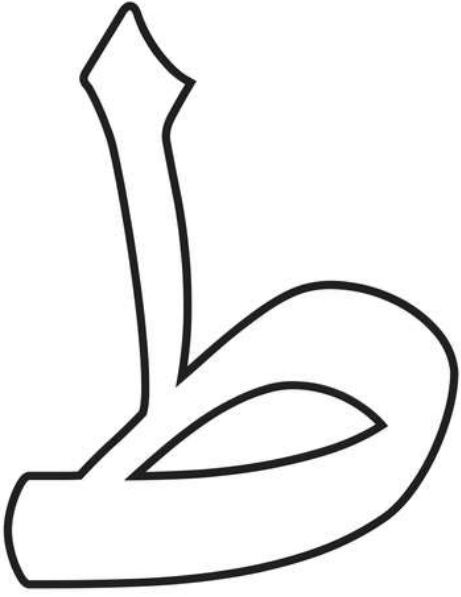

تلوين وكتابة الحرف "ط"

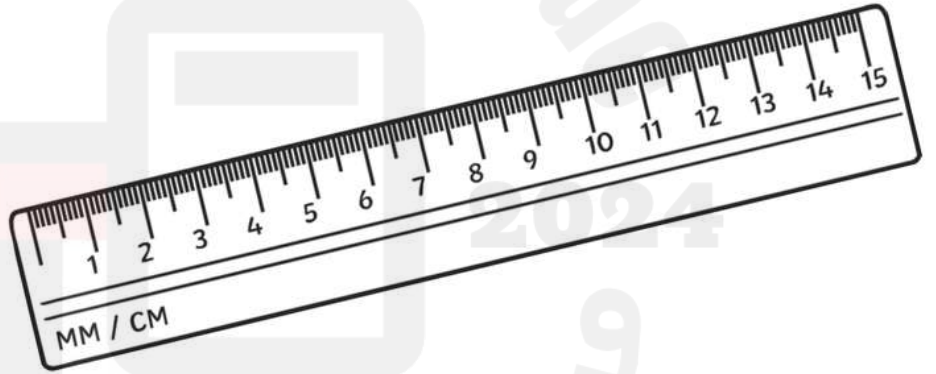

تلوين وكتابة الحرف "ظ"

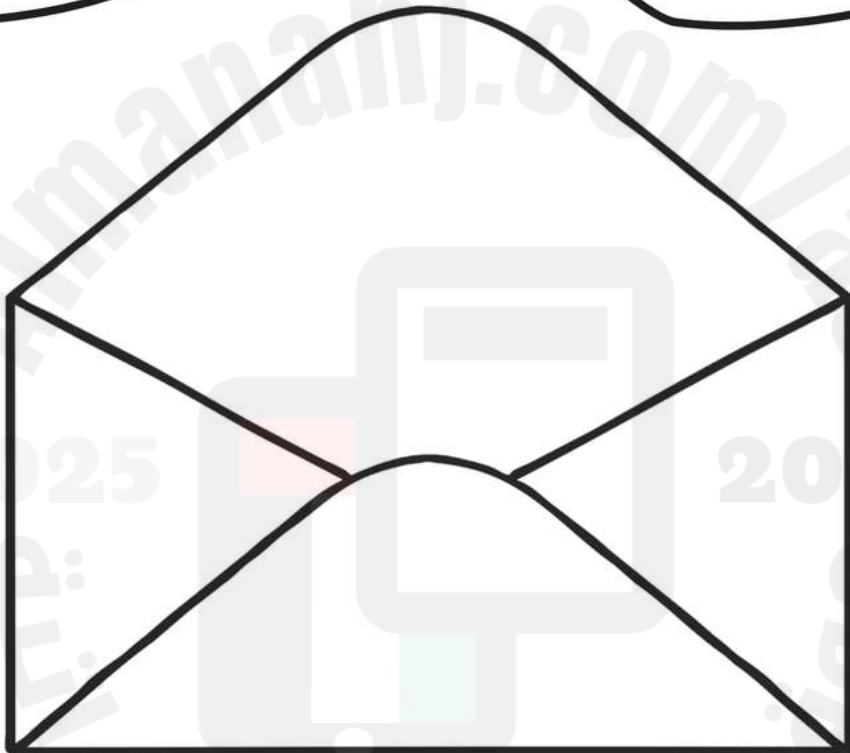

تلوين وكتابة الحرف "ظ"



ظ ظ ظ ظ ظ ظ ظ ظ ظ ظ ظ ظ



تلوين وكتابة الحرف "ع"

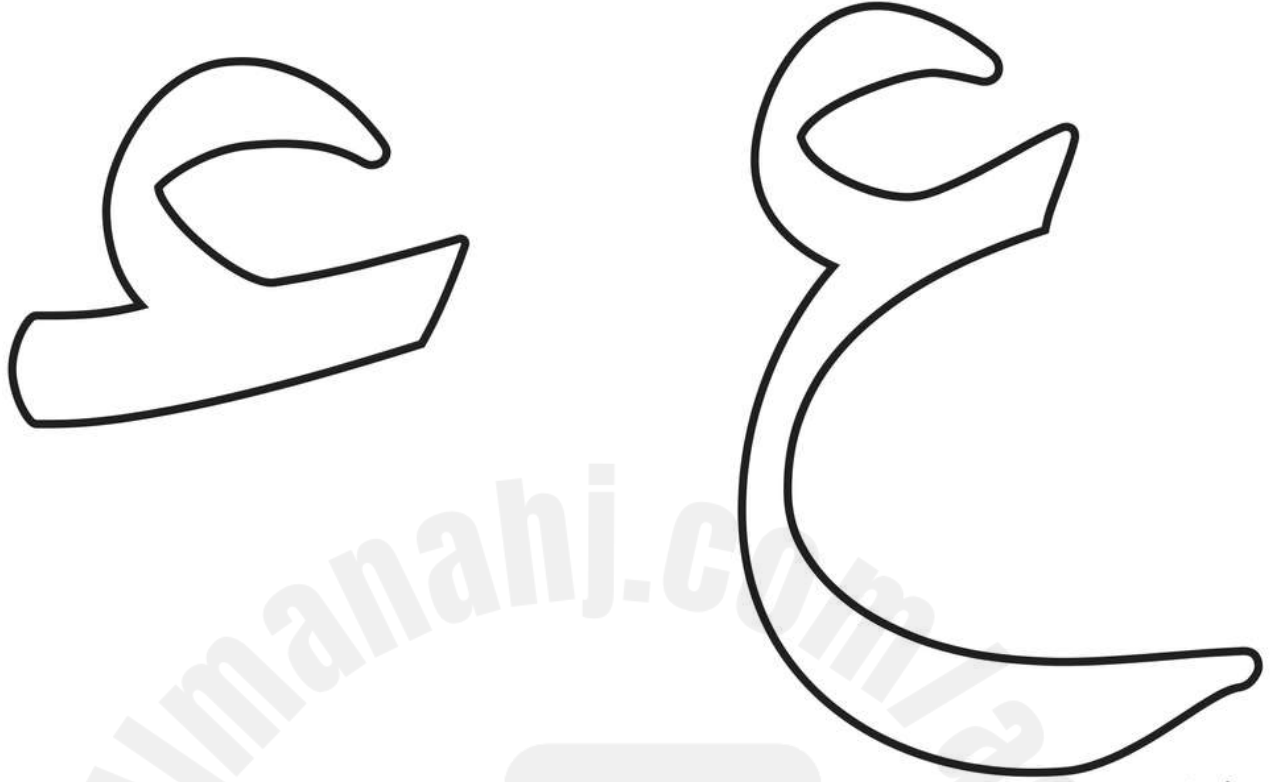

تلوين وكتابة الحرف "ع"

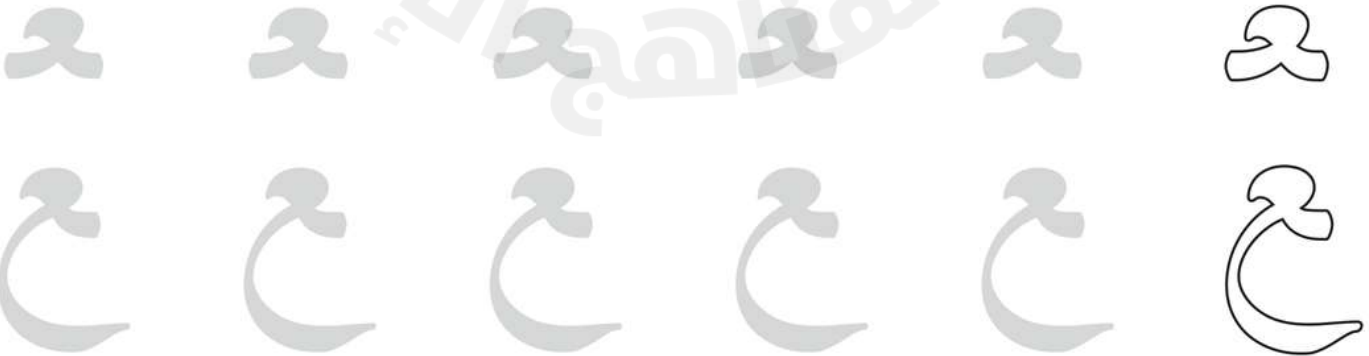
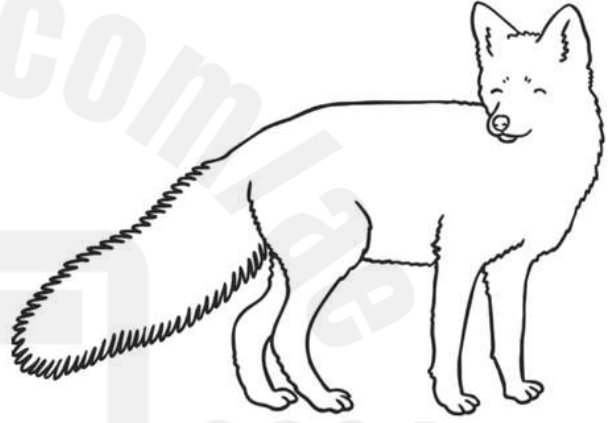
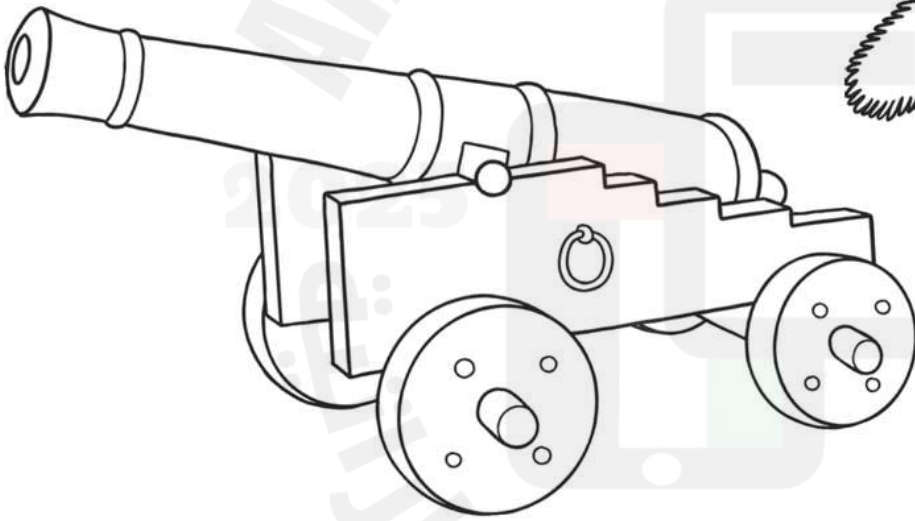
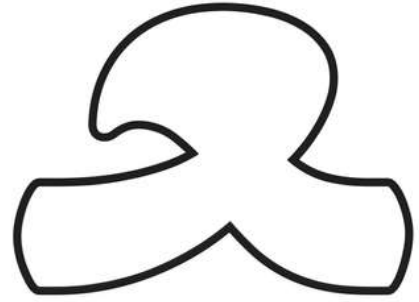
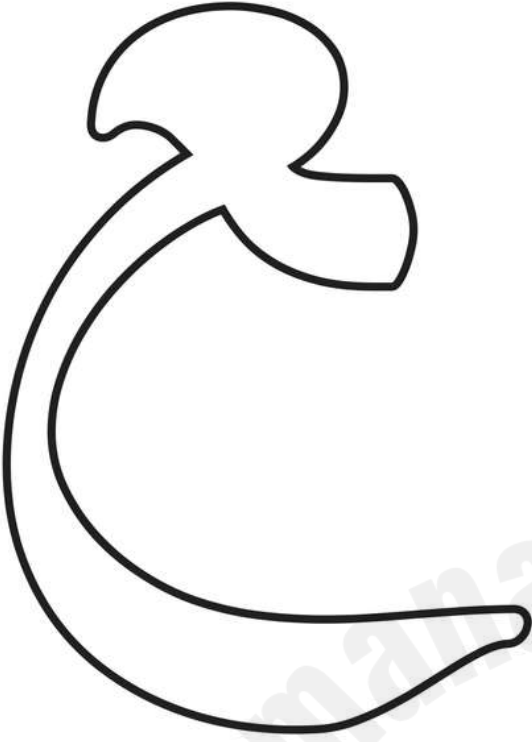

تلوين وكتابة الحرف "غ"

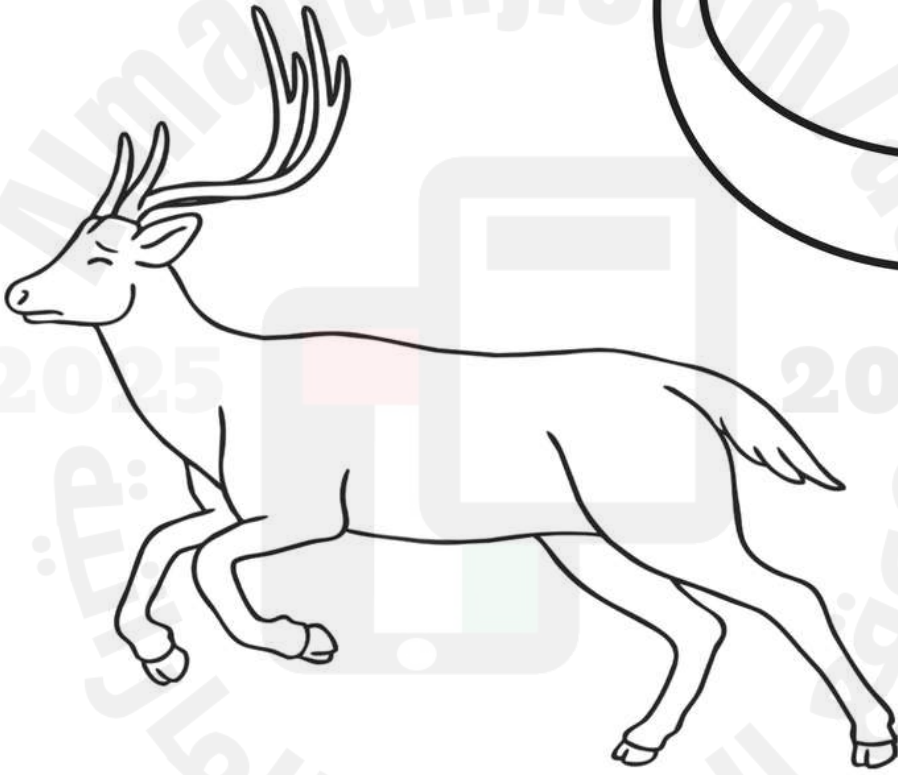
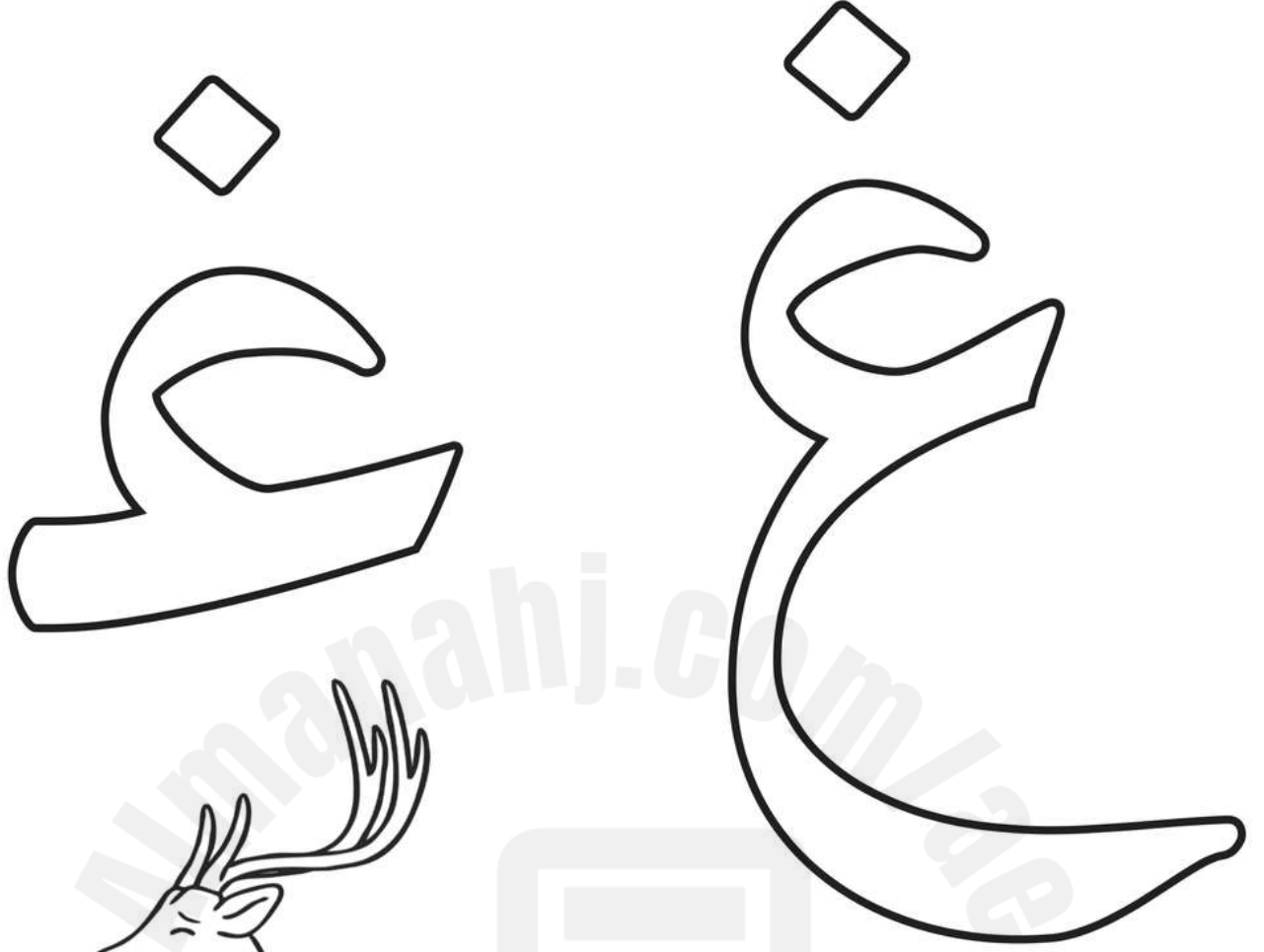

تلوين وكتابة الحرف "غ"

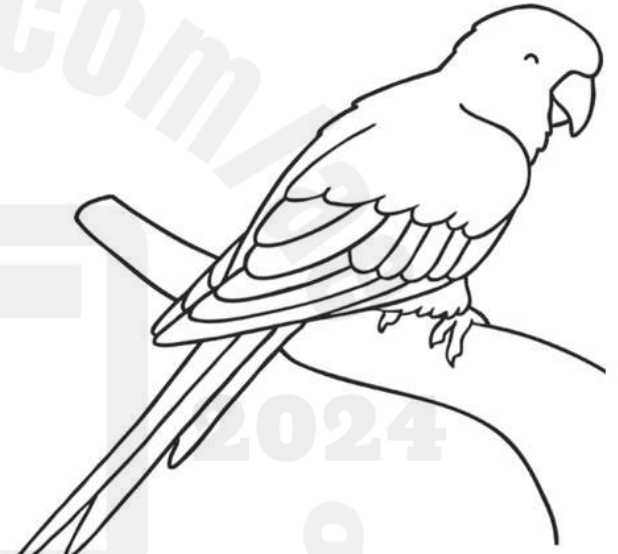
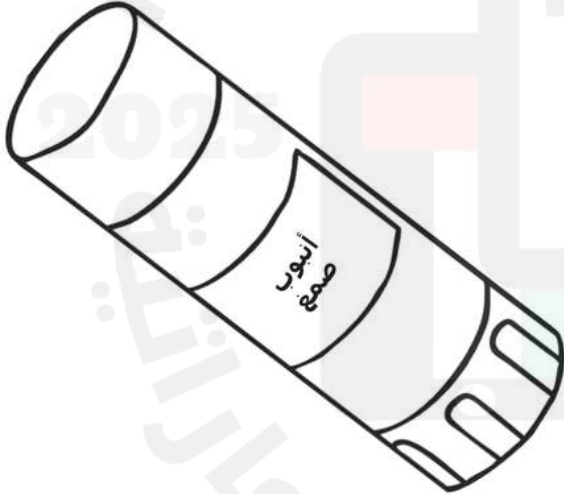
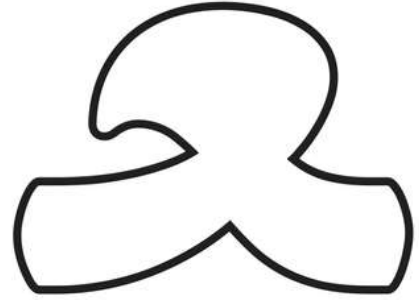

تلوين وكتابة الحرف "ف"

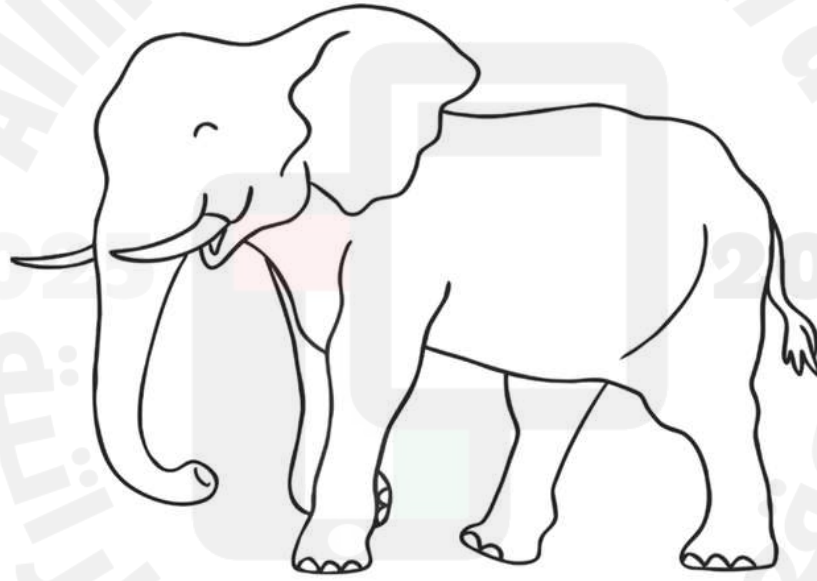

تلوين وكتابة الحرف "ف"

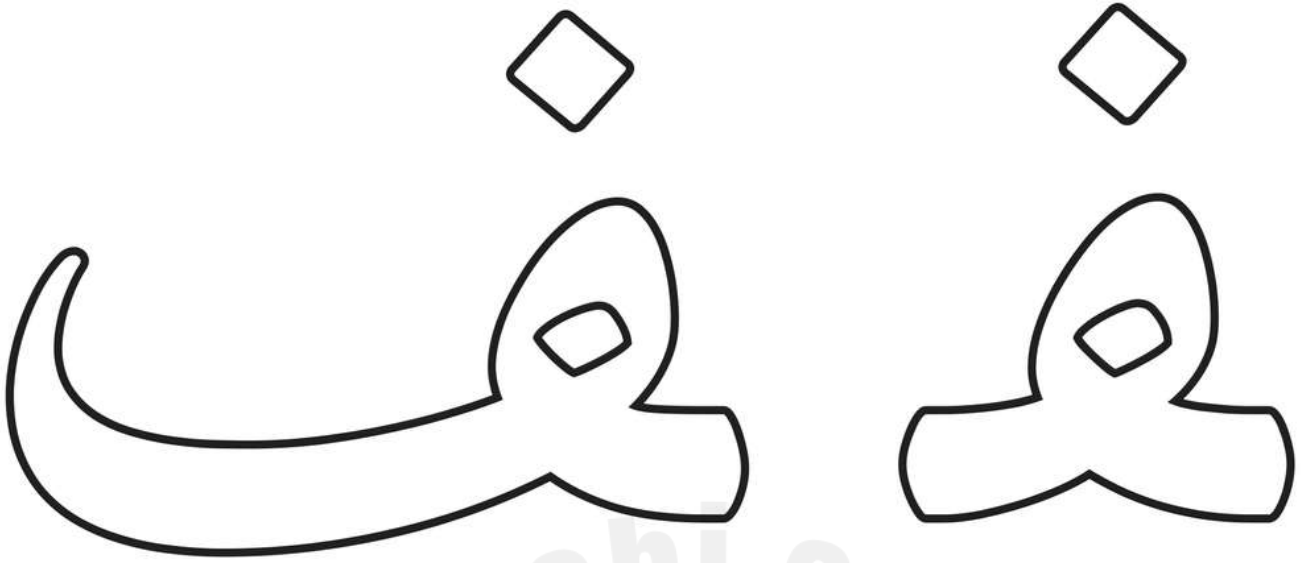

تلوين وكتابة الحرف "ق"

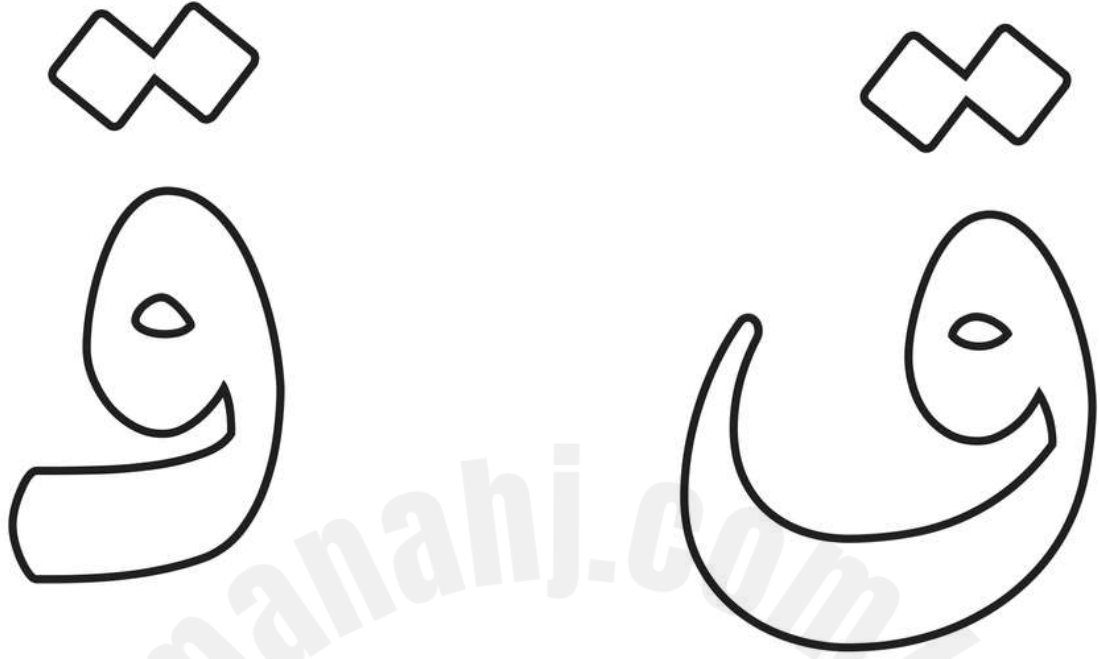

تلوين وكتابة الحرف "ق"

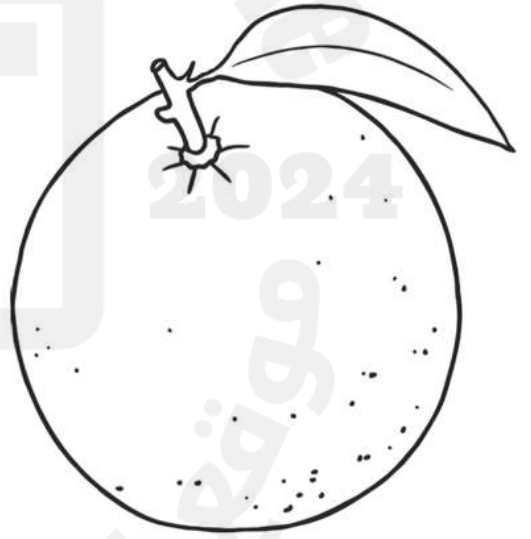
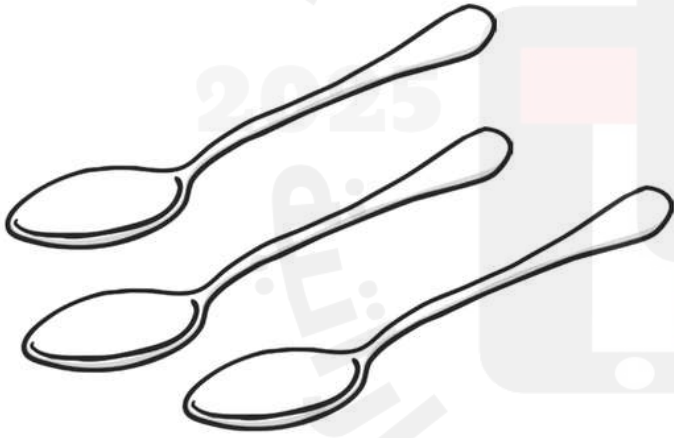
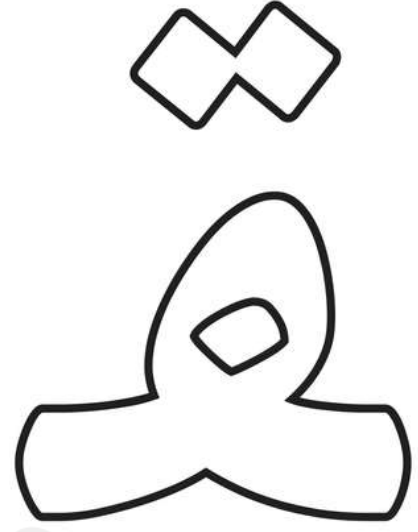
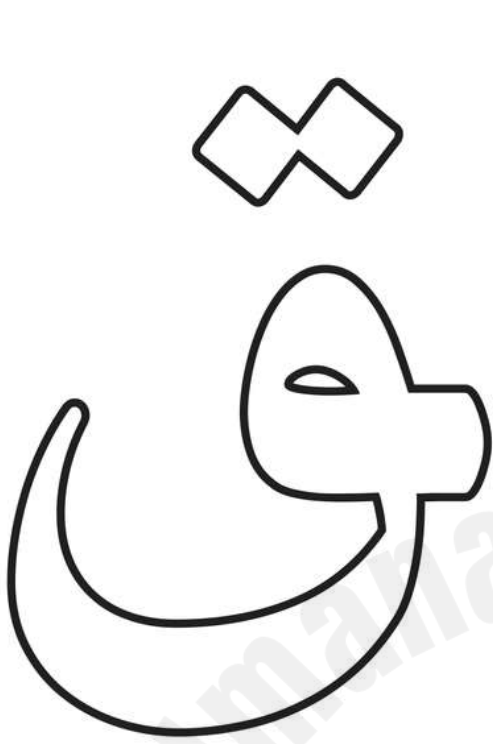

تلوين وكتابة الحرف "ك"

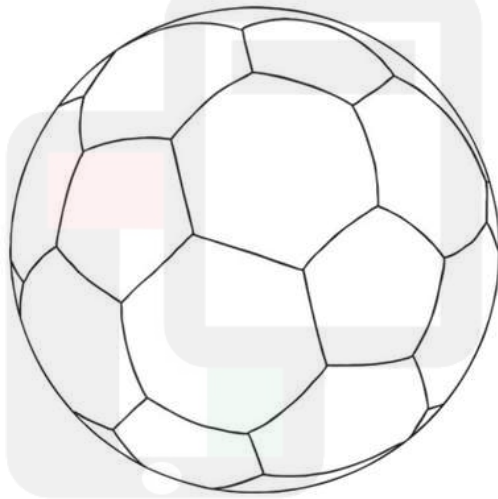
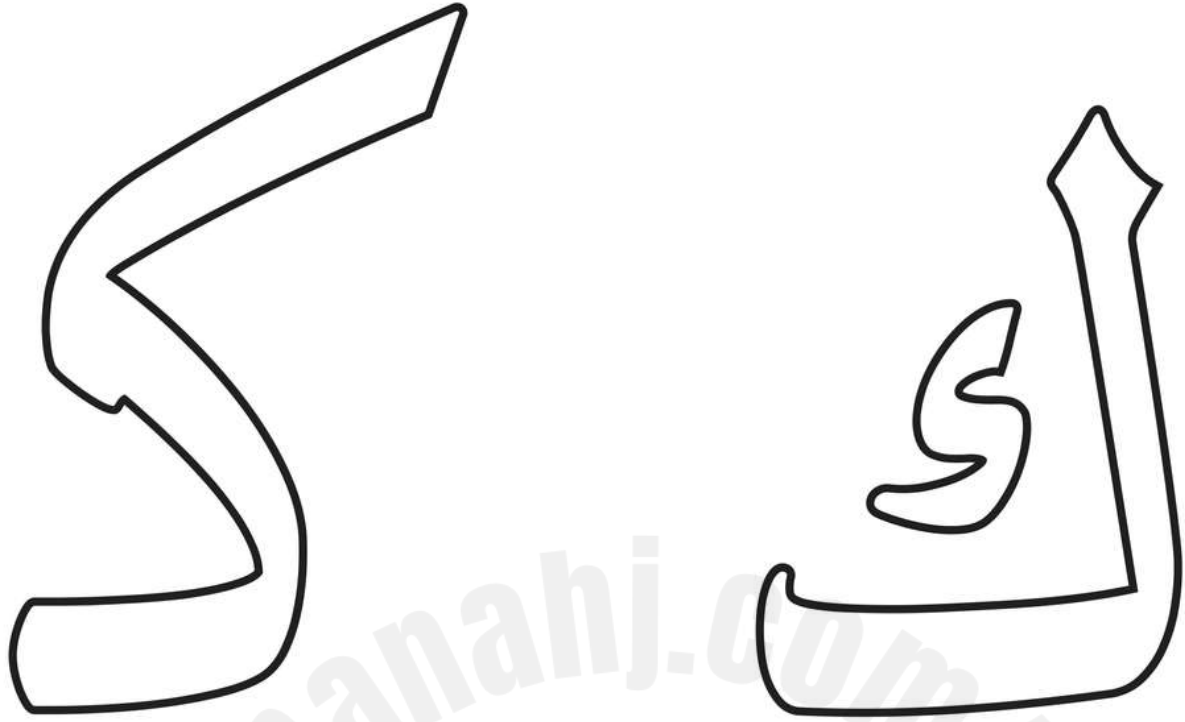

تلوين وكتابة الحرف "ك"

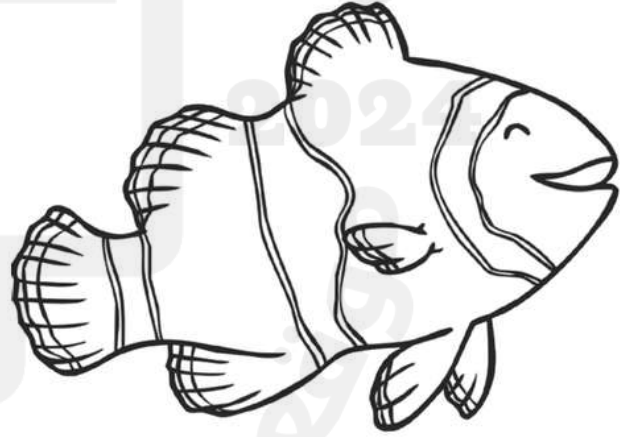
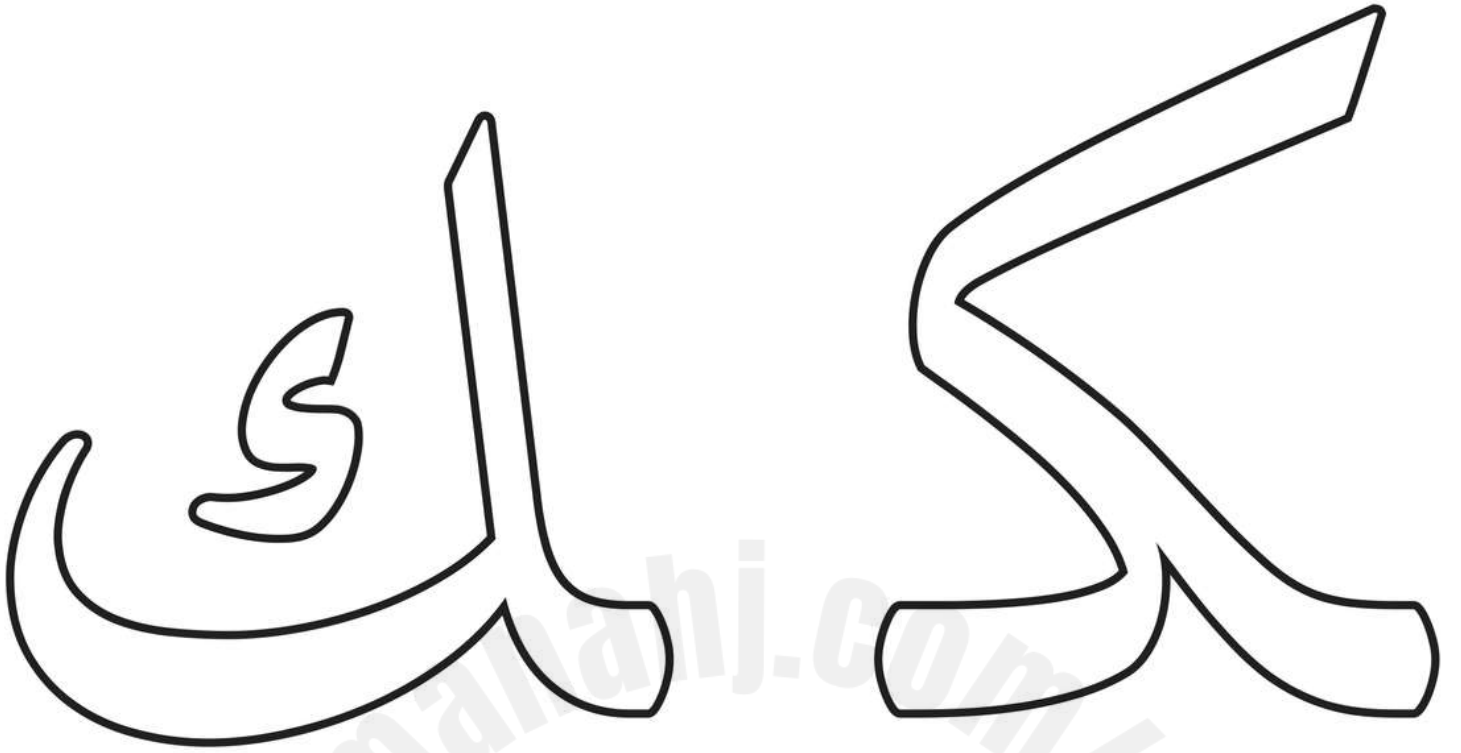

تلوين وكتابة الحرف "ل"

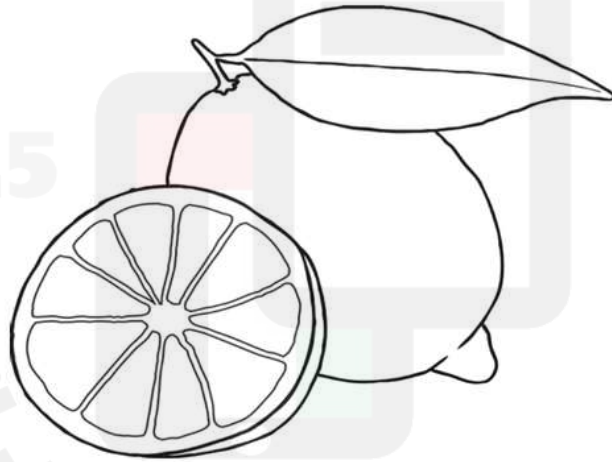
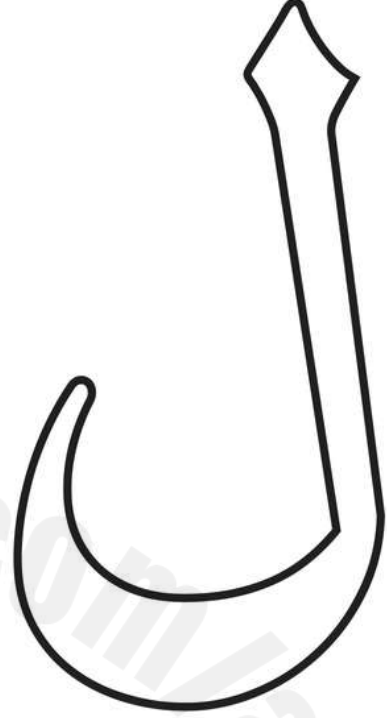

تلوين وكتابة الحرف "ل"

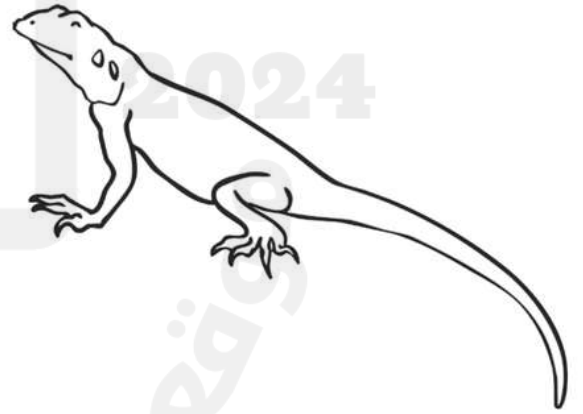
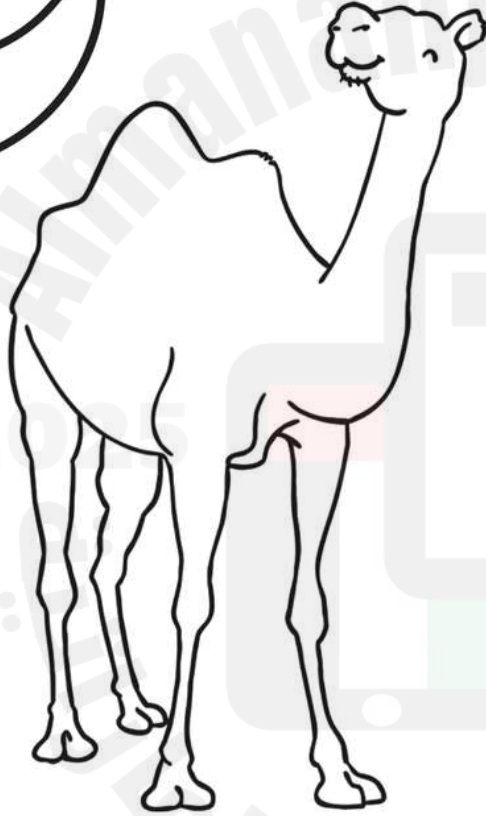
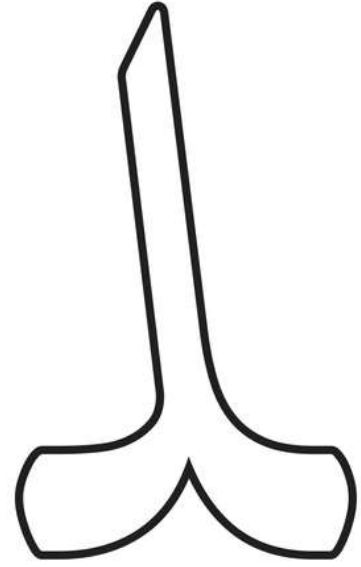
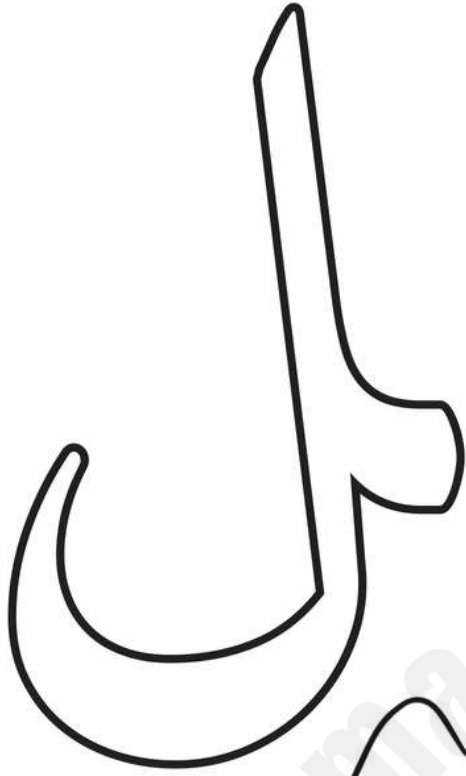

تلوين وكتابة الحرف "م"

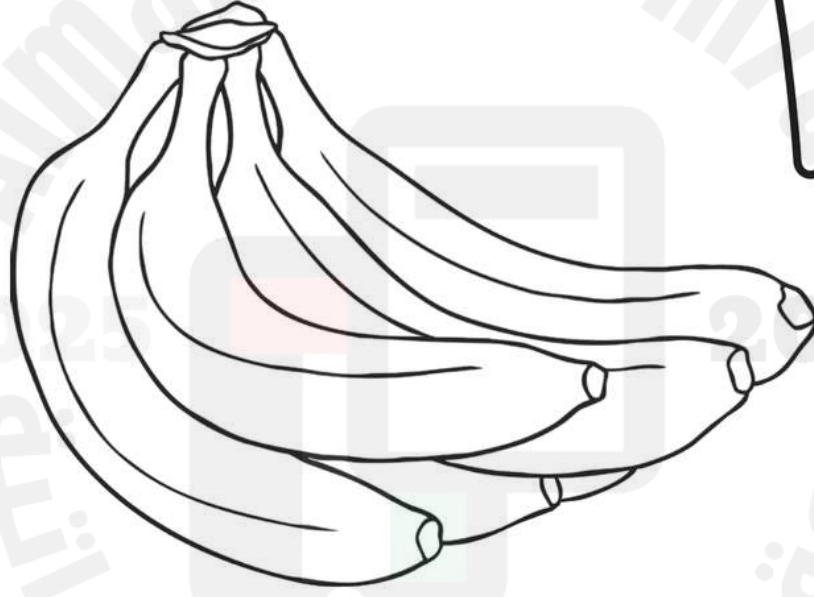
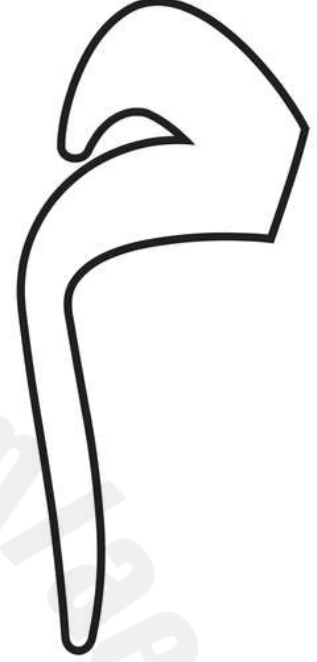
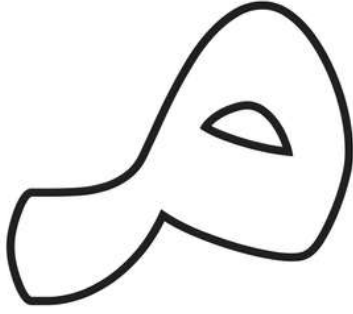

تلوين وكتابة الحرف "م"

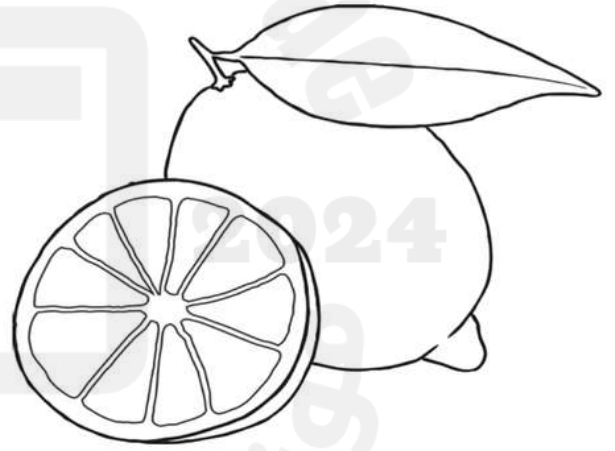
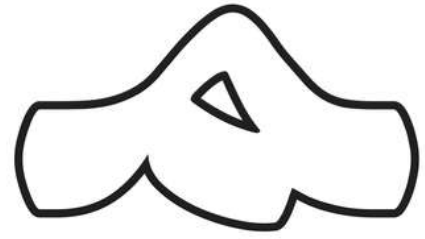

تلوين وكتابة الحرف "ن"

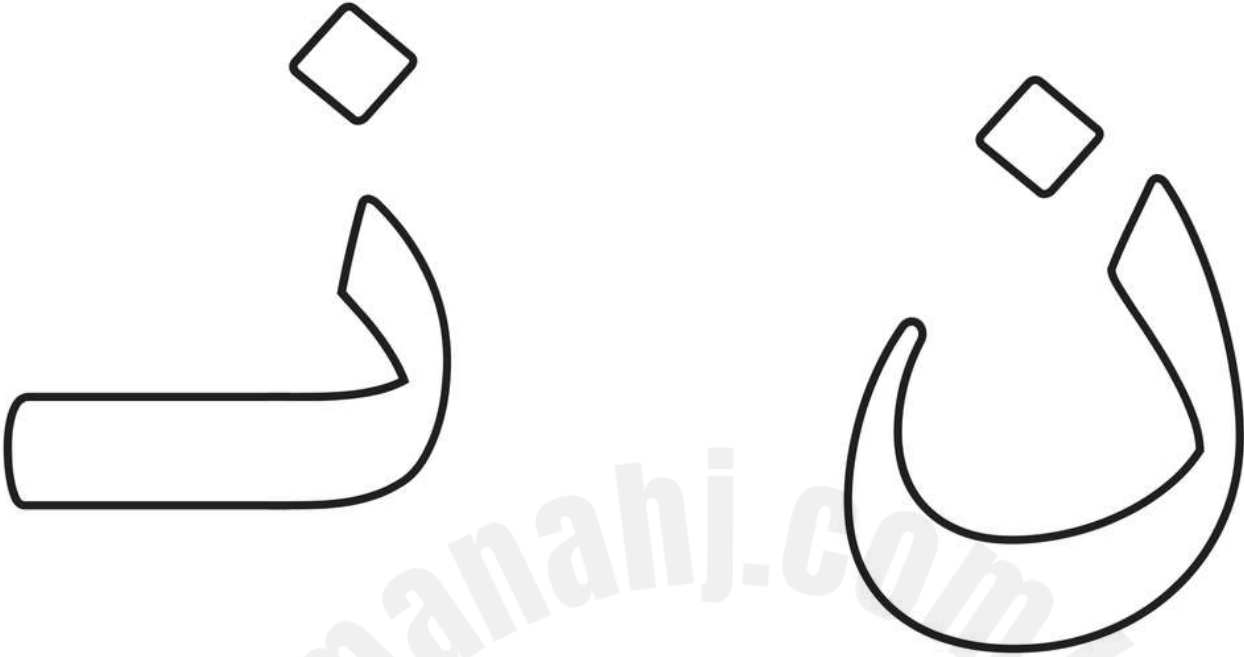

تلوين وكتابة الحرف "ن"

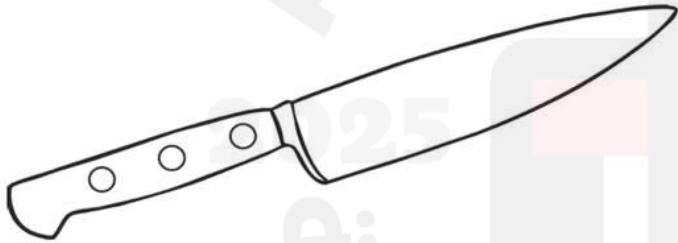
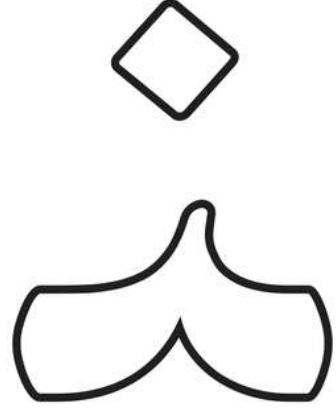
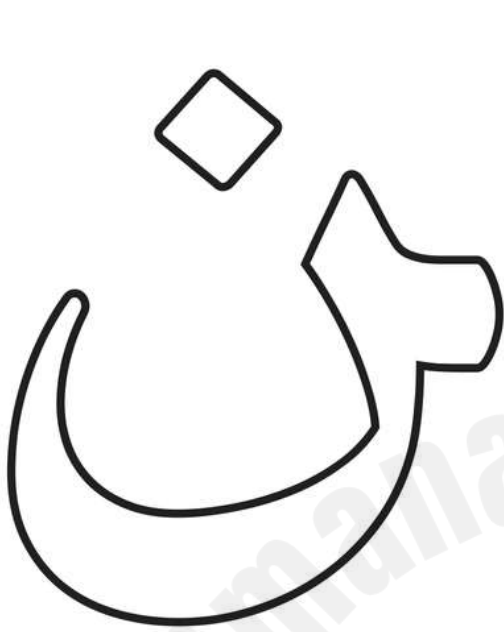

تلوين وكتابة الحرف "هـ"

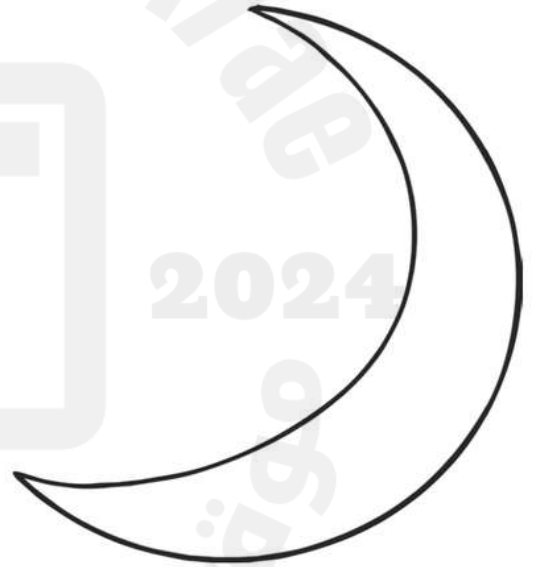

تلوين وكتابة الحرف "هـ"

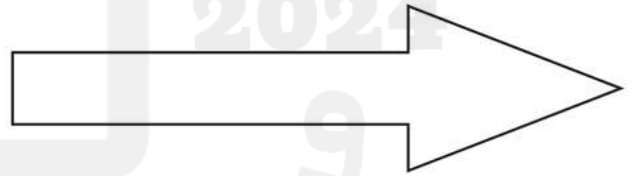
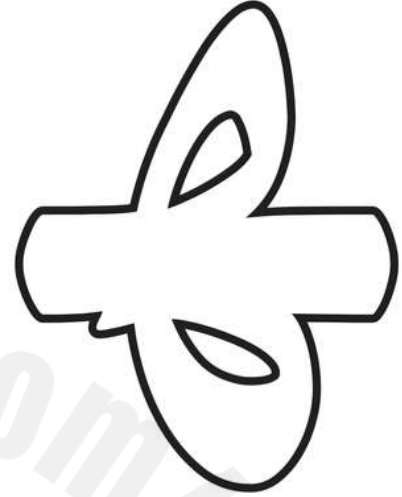
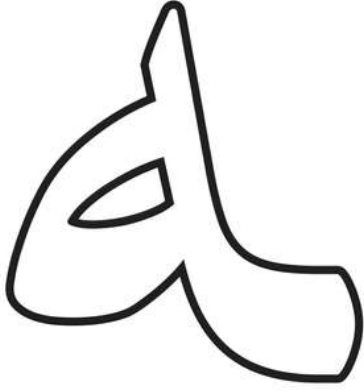

تلوين وكتابة الحرف "و"

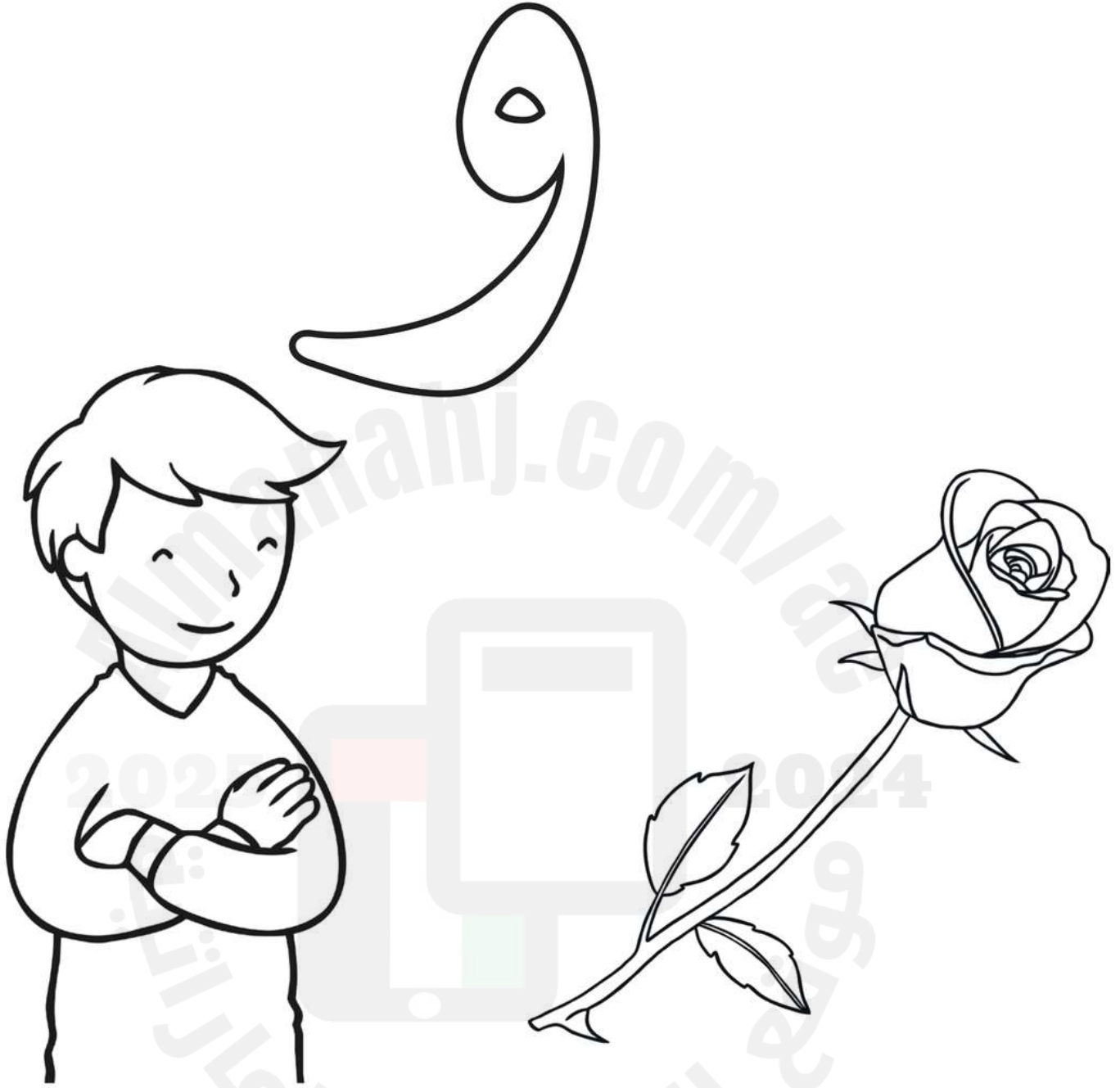

تلوين وكتابة الحرف "و"

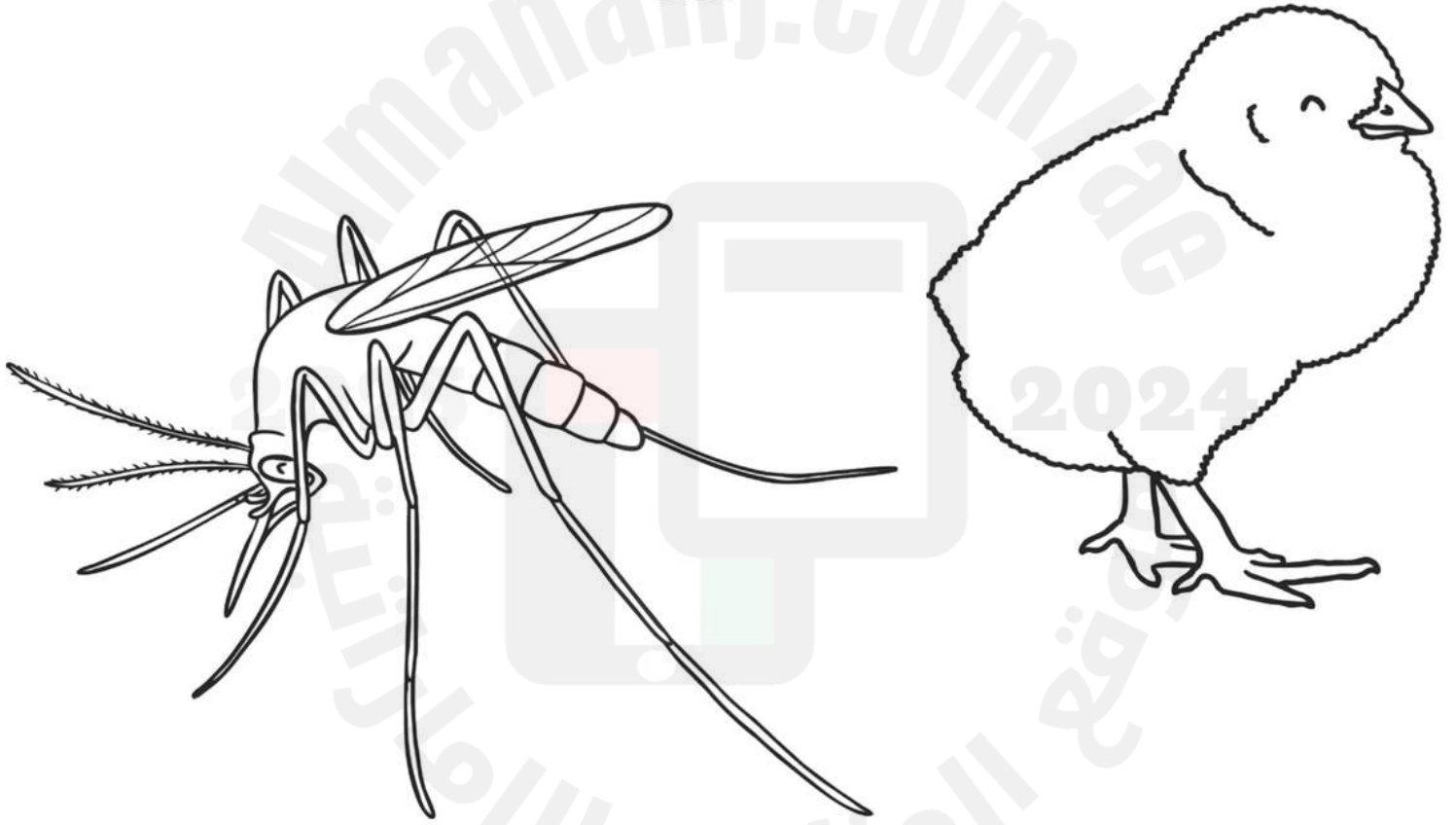

تلوين وكتابة الحرف "ي"

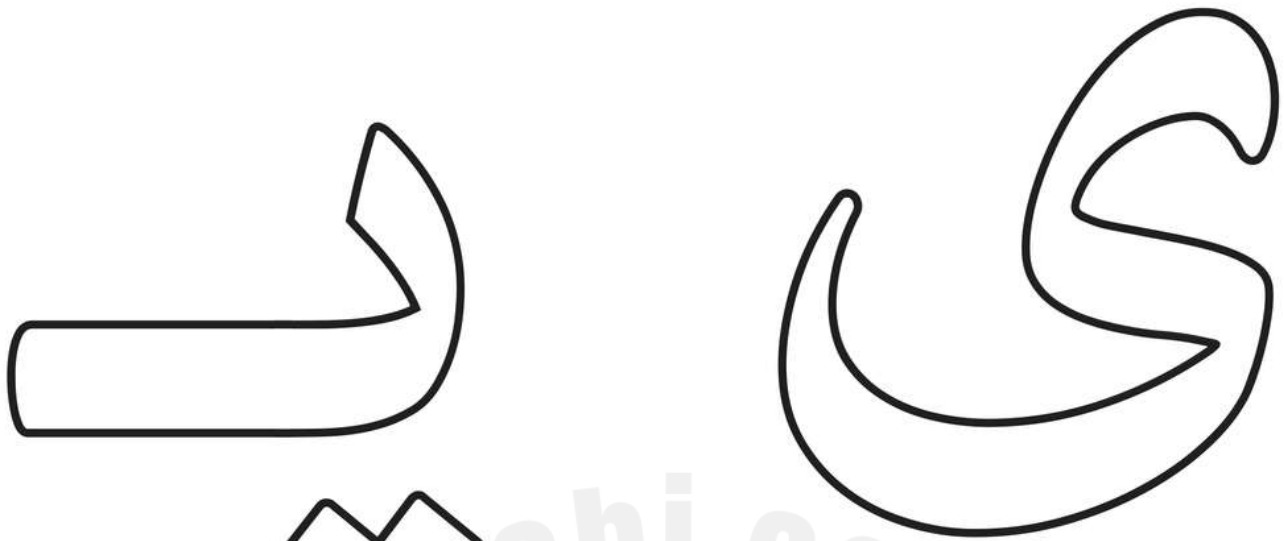

ي

ي

ي

ي

ي

ي

يا

يا

يا

يا

يا

يا



تلوين وكتابة الحرف "ي"

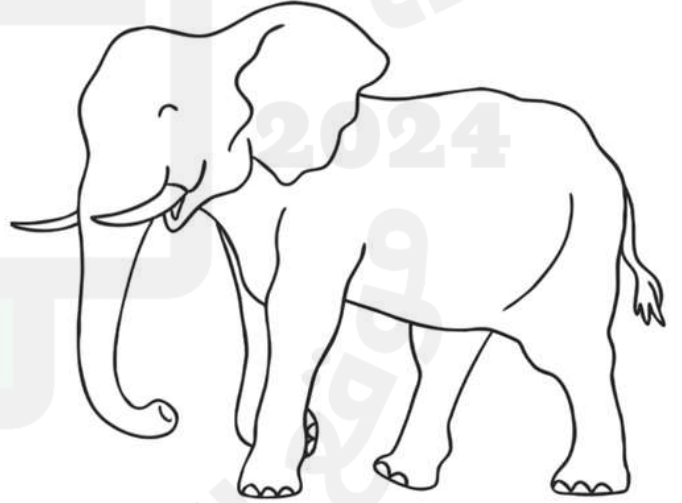
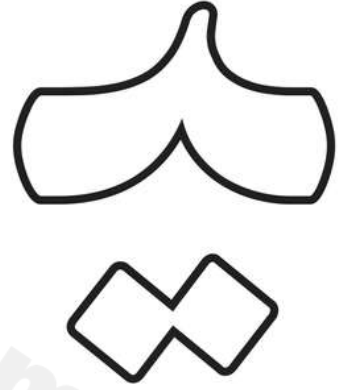
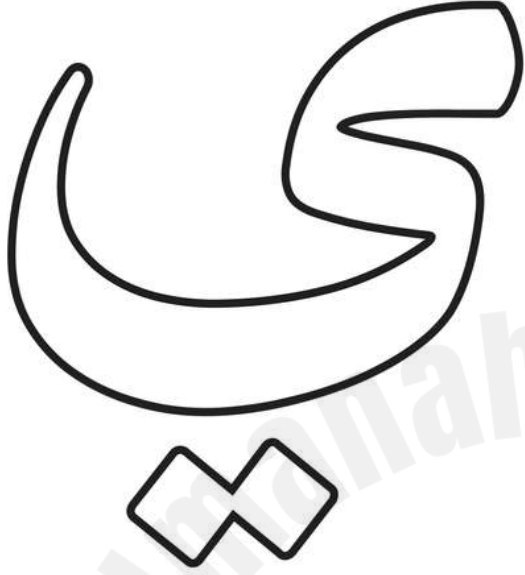

كتابي الرابع عن الأبجدية العربية

ع

س

ش

ص

