

تم تحميل هذا الملف من موقع المناهج البحرينية



## الملف REVIEW 1 TEST /3 GRADE

[موقع المناهج](#) ← [الصف الثالث](#) ← [لغة انجليزية](#) ← [الفصل الأول](#) ← [الملف](#)

## روابط مواقع التواصل الاجتماعي بحسب الصف الثالث



## روابط مواد الصف الثالث على تلغرام

[الرياضيات](#)

[اللغة الانجليزية](#)

[اللغة العربية](#)

[التربية الاسلامية](#)

## المزيد من الملفات بحسب الصف الثالث والمادة لغة انجليزية في الفصل الأول

<a href="#">مراجعة الوحدة الخامسة</a>	1
<a href="#">مراجعة الوحدة الخامسة</a>	2
<a href="#">Worksheet A unit 5</a>	3
<a href="#">ورقة عمل خاصة بالوحدة الخامسة</a>	4
<a href="#">نشاط خاص بالوحدة الخامسة</a>	5

## GRADE 3/ TEST 1 REVIEW

**Q1: Write the correct word under the correct picture.**

have breakfast / go to school / have dinner / get up / go to bed / go home

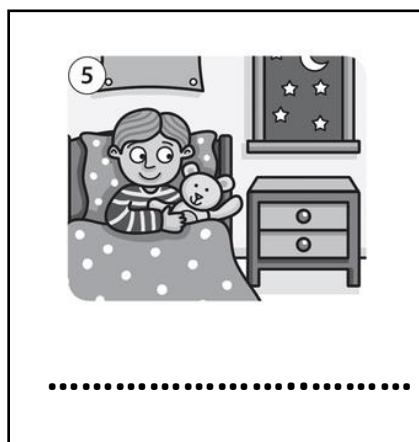
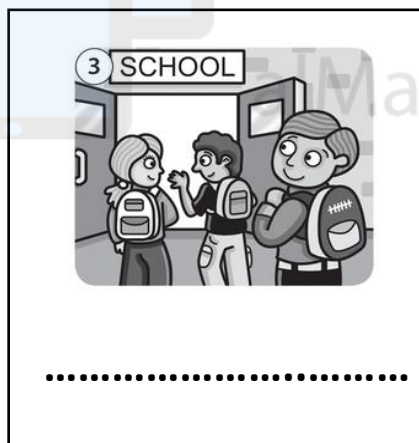
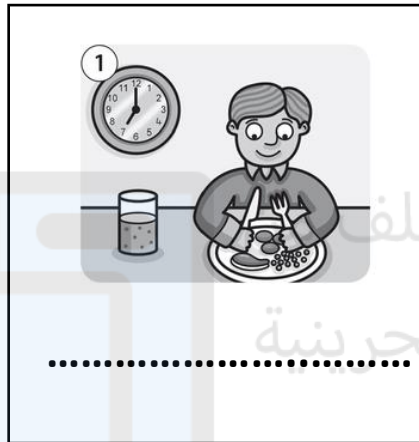

**Q2: Read and draw the correct time on the clock.**

Amal gets up at 5 o'clock. She has breakfast at 6 o'clock. She goes to school at 7 o'clock. She goes home at 12 o'clock. She has dinner at 8 o'clock. She goes to bed at 9 o'clock.

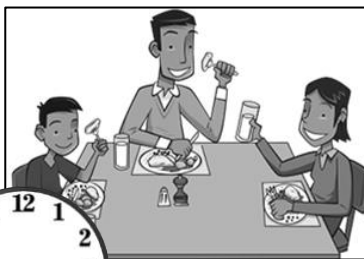
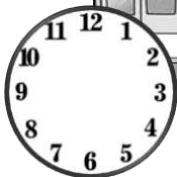
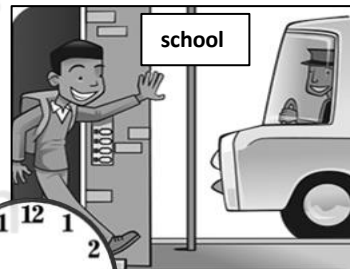

**Q3: write the correct word under the correct picture.**

**In the morning/ in the afternoon/ in the evening/ at night**

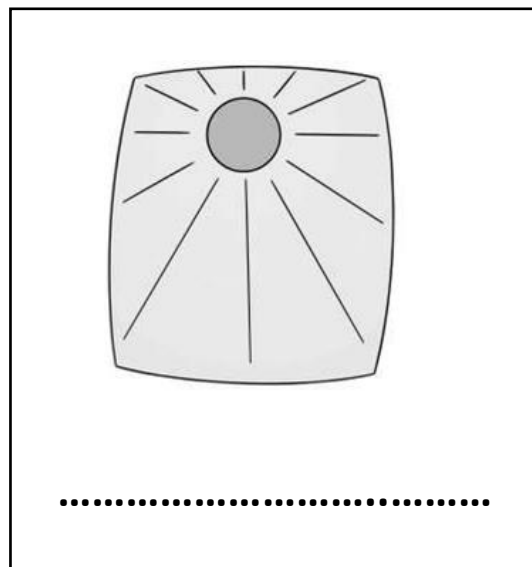
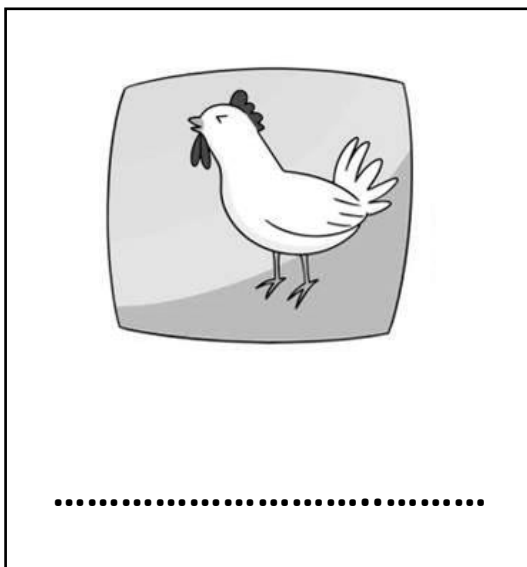
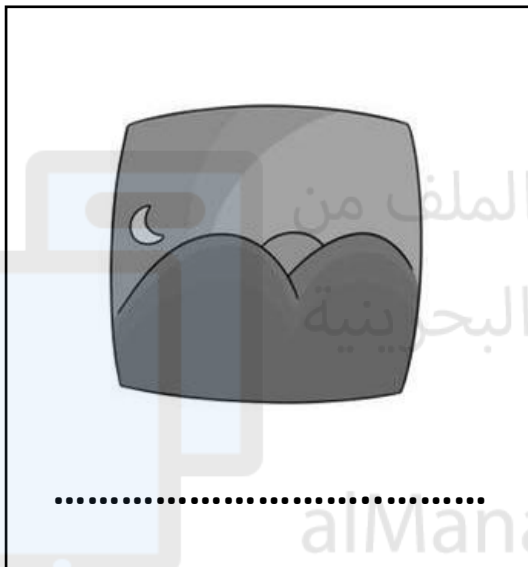

**Q4: Look at the pictures and complete the missing blank with the correct letters.**

sn - sm - sk - st



.....nake



.....ates



.....ar



.....ile



.....y

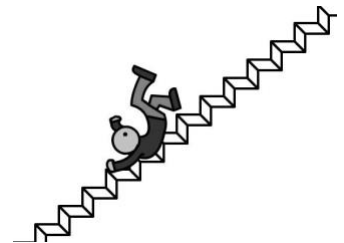

.....airs

**Q5: Write about your daily routine using the following points:**

**1- Name.**

**2- Age**

**3- What do you do every day and at what time. ( At least 3 full correct sentences)**

**Example: I get up at 5 o'clock.**



<b>Rubric</b>	<input type="radio"/> Writing using all the points.	<b>5 points.</b>
	<input type="radio"/> Writing on a form of a paragraph.	<b>0.5 points.</b>
	<input type="radio"/> Writing on the lines	<b>0.5 points.</b>